

**TimberTech**  
BY AZEK

**AZEK**  
EXTERIORS

DECKING, RAILING, SIDING, TRIM & ACCESSORIES  
PRODUCT GUIDE | 2024



# TimberTech®

EVERYTHING WOOD SHOULD BE®

Advanced PVC Decking.....	6
Advanced PVC Porch.....	9
Composite Decking.....	10
Decking Fasteners.....	15
Railing Overview.....	20
Composite Railing.....	22
PVC Railing.....	30
Metal Railing.....	32
Composite & Metal ADA Railing.....	38
Railing Accessories.....	39
Lighting.....	40
Dryspace & Decking Accessories.....	41



Shown here & front cover: Vintage Collection® in English Walnut®  
Impression Rail Express® in Dark Bronze

# AZEK<sup>®</sup> EXTERIORS

Trim.....	42
Moulding.....	48
Shingle Siding.....	52
Bevel Siding, Board and Batten Siding ..	53
TimberTech Cladding.....	54
Adhesive and Tools.....	56
Cortex .....	58



# TimberTech®

## #1 in premium decking

With the highest quality decking and railing, plus outstanding service, TimberTech is the go-to choice for contractors and homeowners.



Landmark Collection™ in Castle Gate™  
Classic Composite Series in Matte Black with Drink Rail



## Unrivaled real wood looks

The most convincing aesthetics with more colors and textures than any other brand



## Proprietary technology

Industry-leading tech for a cooler touch and top-rated fire resistance



## Sustainably made

With up to 85% recycled materials, our decking is more sustainable than wood

**TimberTech**  
 ADVANCED PVC  
 BY AZEK



# Our most realistic wood looks with unparalleled performance

- TOP-RATED FIRE RESISTANCE** Class A Flame Spread Rating, WUI-compliance, or both
- SUSTAINABLE** Made in the USA from approximately 60% recycled material
- SUPER DURABLE** Highly moisture-resistant & won't splinter, crack, peel, or rot
- LOW MAINTENANCE** No sanding, staining, or sealing—ever
- FADE RESISTANT** Maintains its rich color for decades\*
- FRIENDLIER TO BARE FEET** Up to 30° cooler & up to 40% better traction than the competition\*\*
- INDUSTRY-LEADING WARRANTIES** 50-Year Fade & Stain and Lifetime Product Limited Warranties
- DESIGN VERSATILITY** Multiwidth Decking options and heat-bending capabilities

Vintage Collection® in Multiwidth Weathered Teak®  
 Impression-Rail Express®, Modern Top Rail

\*Depending on environmental conditions, TimberTech Composite Deck colors may appear to change over time as part of the natural weathering process consistent with the warranty guarantees where applicable. \*\*Although TimberTech PVC Decking is cooler to the touch than many other deck board products, all decking products will get hot in the sun. Additionally, the darker the decking color, the hotter it will feel. For hotter climates, consider choosing a lighter color.

# VINTAGE COLLECTION®

## Exotic Hardwoods

Give your clients the look of sought-after premium hardwoods like ipe, mahogany, and teak with the Vintage Collection. Featuring a refined wire-brushed finish and multi-tonal color blending with highlights and lowlights, this collection delivers a truly authentic wood look.

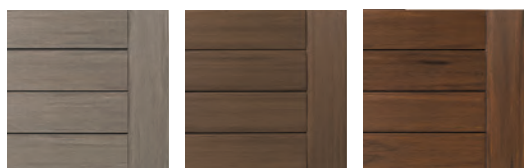

COASTLINE\*

ENGLISH WALNUT\*

MAHOGANY



WEATHERED TEAK\*

DARK HICKORY

CYPRESS\*

## CLASS A FLAME SPREAD INDEX & WUI-COMPLIANT

### FOR HOMES IN FIRE ZONES

With a Class A Flame Spread Index rating and WUI compliance, the Vintage Collection is our best choice for homes in fire zones.

## MULTIWIDTH DECKING

### FOR DESIGN FLEXIBILITY

For design-forward clients, choose from narrow (3.5"), standard (5.5"), and wide (7.25") width deck boards to create a curated design. Available with all colors in the Vintage Collection.

## MAX DECKING

### FOR WIDER JOIST SPANS

MAX boards are 1.5" thick and can span up to 24" on center, making them ideal for docks, boardwalks, and many decking applications. Available in Coastline.

PRODUCT DESCRIPTION	TimberTech Model Number		
	12'	16'	20'
<b>VINTAGE COLLECTION®</b>			
1 x 4 Square-Shouldered Coastline	—	ADB13516CS	ADB13520CS
1 x 6 Square-Shouldered Coastline	—	ADB15516CS	ADB15520CS
2 x 6 Square-Shouldered Coastline MAX	ADB25512CS	ADB25516CS	ADB25520CS
1 x 6 Grooved Coastline	AGB15512CS	AGB15516CS	AGB15520CS
1 x 8 Square-Shouldered Coastline	—	ADB172516CS	ADB172520CS
1 x 4 Square-Shouldered English Walnut	—	ADB13516EW	ADB13520EW
1 x 6 Square-Shouldered English Walnut	—	ADB15516EW	ADB15520EW
1 x 6 Grooved English Walnut	AGB15512EW	AGB15516EW	AGB15520EW
1 x 8 Square-Shouldered English Walnut	—	ADB172516EW	ADB172520EW
1 x 4 Square-Shouldered Weathered Teak	—	ADB13516WT	ADB13520WT
1 x 6 Square-Shouldered Weathered Teak	—	ADB15516WT	ADB15520WT
1 x 6 Grooved Weathered Teak	AGB15512WT	AGB15516WT	AGB15520WT
1 x 8 Square-Shouldered Weathered Teak	—	ADB172516WT	ADB172520WT
1 x 4 Square-Shouldered Mahogany	—	ADB13516MH	ADB13520MH
1 x 6 Square-Shouldered Mahogany	—	ADB15516MH	ADB15520MH
1 x 6 Grooved Mahogany	AGB15512MH	AGB15516MH	AGB15520MH
1 x 8 Square-Shouldered Mahogany	—	ADB172516MH	ADB172520MH
1 x 4 Square-Shouldered Dark Hickory	—	ADB13516DH	ADB13520DH
1 x 6 Square-Shouldered Dark Hickory	—	ADB15516DH	ADB15520DH
1 x 6 Grooved Dark Hickory	AGB15512DH	AGB15516DH	AGB15520DH
1 x 8 Square-Shouldered Dark Hickory	—	ADB172516DH	ADB172520DH
1 x 4 Square-Shouldered Cypress	—	ADB13516CY	ADB13520CY
1 x 6 Square-Shouldered Cypress	—	ADB15516CY	ADB15520CY
1 x 6 Grooved Cypress	AGB15512CY	AGB15516CY	AGB15520CY
1 x 8 Square-Shouldered Cypress	—	ADB172516CY	ADB172520CY
<b>VINTAGE FASCIA</b>			
12" Fascia Coastline	ADR5117512CS	—	—
12" Fascia English Walnut	ADR5117512EW	—	—
12" Fascia Weathered Teak	ADR5117512WT	—	—
12" Fascia Mahogany	ADR5117512MH	—	—
12" Fascia Dark Hickory	ADR5117512DH	—	—
12" Fascia Cypress	ADR5117512CY	—	—

## PROFILE OPTIONS



# LANDMARK COLLECTION®

## Crosscut Hardwoods

For a look that resembles popular hardwoods like White oak and walnut, choose the Landmark Collection. Featuring a crosscut cathedral grain with a matte finish and cascading color blending, this collection is perfect for clients looking for a character-rich style.



FRENCH WHITE OAK®

CASTLE GATE™

AMERICAN WALNUT®



BOARDWALK®

# HARVEST COLLECTION®

## Refined Cathedral Grain

Introduce your clients to the inviting versatility of the Harvest Collection, featuring an attractive cathedral grain and soft, solid colors that suit a range of styles.



BROWNSTONE

SLATE GRAY

KONA®

## WUI-COMPLIANT

### FOR HOMES IN FIRE ZONES

With WUI compliance, the Harvest Collection is a better choice for homes in fire zones.

### PROFILE OPTIONS

#### STANDARD



#### WIDE



#### MAX



#### FASCIA

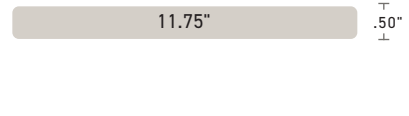

PRODUCT DESCRIPTION	TimberTech Model Number		
	12'	16'	20'
<b>LANDMARK COLLECTION</b>			
1 x 6 Square-Shouldered Castle Gate™	—	ADB15516CG	ADB15520CG
1 x 6 Grooved Castle Gate™	AGB15512CG	AGB15516CG	AGB15520CG
1 x 6 Square-Shouldered American Walnut™	—	ADB15516AW	ADB15520AW
1 x 6 Grooved American Walnut™	AGB15512AW	AGB15516AW	AGB15520AW
1 x 6 Square-Shouldered French White Oak®	—	ADB15516FW	ADB15520FW
1 x 6 Grooved French White Oak®	AGB15512FW	AGB15516FW	AGB15520FW
1 x 6 Square-Shouldered Boardwalk®	—	ADB15516BD	ADB15520BD
1 x 6 Grooved Boardwalk®	AGB15512BD	AGB15516BD	AGB15520BD
<b>LANDMARK FASCIA</b>			
12" Fascia Castle Gate™	ADR5117512CG	—	—
12" Fascia American Walnut™	ADR5117512AW	—	—
12" Fascia French White Oak®	ADR5117512FW	—	—
12" Fascia Boardwalk®	ADR5117512BD	—	—

## CLASS A FLAME SPREAD INDEX & WUI-COMPLIANT

### FOR HOMES IN FIRE ZONES

With a Class A Flame Spread Index rating and WUI compliance, the Vintage Collection is our best choice for homes in fire zones.

### PROFILE OPTIONS

#### STANDARD

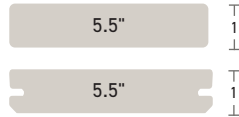

#### FASCIA

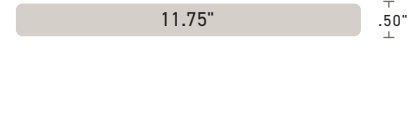

PRODUCT DESCRIPTION	TimberTech Model Number		
	12'	16'	20'
<b>HARVEST COLLECTION</b>			
1 x 6 Square-Shouldered Brownstone	ADCB15512BS	ADCB15516BS	ADCB15520BS
1 x 6 Grooved Brownstone	AGB15512BS	AGB15516BS	AGB15520BS
1 x 8 Square-Shouldered Brownstone	—	ADCB172516BS	ADCB172520BS
1 x 6 Square-Shouldered Slate Gray	ADCB15512SG	ADCB15516SG	ADCB15520SG
1 x 6 Grooved Slate Gray	AGB15512SG	AGB15516SG	AGB15520SG
1 x 8 Square-Shouldered Slate Gray	—	ADCB172516SG	ADCB172520SG
2 x 6 Square-Shouldered Slate Gray MAX	ADCB25512SG	ADCB25516SG	ADCB25520SG
1 x 6 Square-Shouldered Kona®	—	ADB15516KOAAT	ADB15520KOAAT
<b>HARVEST FASCIA</b>			
12" Fascia Brownstone	ADCR5117512BS	—	—
12" Fascia Slate Gray	ADCR5117512SG	—	—
12" Fascia Kona®	ADR5117512KOAAT	—	—

## MULTIWIDTH DECKING

### FOR DESIGN FLEXIBILITY

Slate Gray and Brownstone are available in both standard (5.5") and wide (7.25") widths for curated design options. Kona only available in standard width.

## MAX DECKING

### FOR WIDER JOIST SPANS

MAX boards are 1.5" thick and can span up to 24" on center, making them ideal for docks, boardwalks, and many decking applications. Available in Slate Gray.



New



Porch Collection in English Walnut® Classic Composite Series Drink Rail

## PORCH COLLECTION

### Hardwoods & Stained Wood

Bring all the real wood looks and performance benefits of TimberTech Advanced PVC Decking to your clients' porches. The innovative tongue-and-groove installation of our Porch Collection allows for smaller gaps between boards—delivering a traditional hardwood flooring look your clients will love.



SLATE GRAY



OYSTER®

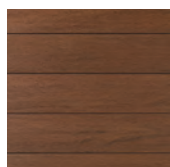

MAHOGANY



DARK HICKORY

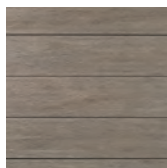

COASTLINE\*

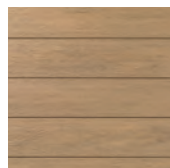

WEATHERED TEAK\*

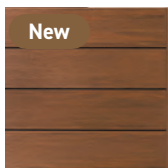

CYPRESS\*

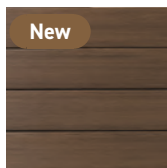

ENGLISH WALNUT\*

PRODUCT DESCRIPTION	TimberTech Model Number		
	10'	12'	16'
<b>ADVANCED PVC PORCH</b>			
1 x 4 T&G Porch Slate Gray	ADCP13510SG	ADCP13512SG	ADCP13516SG
1 x 4 T&G Porch Oyster	—	ADP13512OR	ADP13516OR
1 x 6 T&G Porch Mahogany	—	ADP15512MH	ADP15516MH
1 x 4 T&G Porch Mahogany	—	ADP13512MH	ADP13516MH
1 x 6 T&G Porch Dark Hickory	—	ADP15512DH	ADP15516DH
1 x 4 T&G Porch Dark Hickory	—	ADP13512DH	ADP13516DH
1 x 6 T&G Porch Coastline	—	ADP15512CS	ADP15516CS
1 x 4 T&G Porch Coastline	—	ADP13512CS	ADP13516CS
1 x 6 T&G Porch Weathered Teak	—	ADP15512WT	ADP15516WT
1 x 4 T&G Porch Weathered Teak	—	ADP13512WT	ADP13516WT
1 x 4 T&G Porch Cypress	—	ADP13512CY	ADP13516CY
1 x 6 T&G Porch Cypress	—	ADP15512CY	ADP15516CY
1 x 4 T&G Porch English Walnut	—	ADP13512EW	ADP13516EW
1 x 6 T&G Porch English Walnut	—	ADP15512EW	ADP15516EW

Extended lead times may apply to certain geographies.

## MULTIWIDTH PORCH BOARDS

### FOR DESIGN FLEXIBILITY

Standard-width (3.125") width boards available in all colors. Wide-width (5.5") porch boards available in Coastline, Cypress, Dark Hickory, English Walnut, Mahogany, and Weathered Teak for curated design options.

## WUI-COMPLIANT

### FOR HOMES IN FIRE ZONES

With WUI compliance, the Porch Collection is a better choice for homes in fire zones.

### PROFILE OPTIONS

#### STANDARD

3.125" T  
1" L

#### WIDE

5.5" T  
1" L



# Composite in a class of its own, with unmatched wood looks

**DURABLE** Won't split, splinter, or rot

**LOW MAINTENANCE** No sanding, staining, or sealing—ever

**FADE RESISTANT** Maintains its rich color for decades\*

**MOISTURE RESISTANT** Protected from mold, mildew, and rot

**WARRANTY PROTECTION** 30- and 25-year limited warranties that vary by collection\*\*

**SUSTAINABLE** Made in the USA from approximately 85% recycled material

**BETTER SIDED CAPPING MAKES THE DIFFERENCE**

Four-sided capping for superior moisture resistance

Three-sided capping for excellent moisture resistance

**COLLECTIONS**

Legacy, Reserve, Terrain+™, Terrain®

Prime+®, Prime, Premier

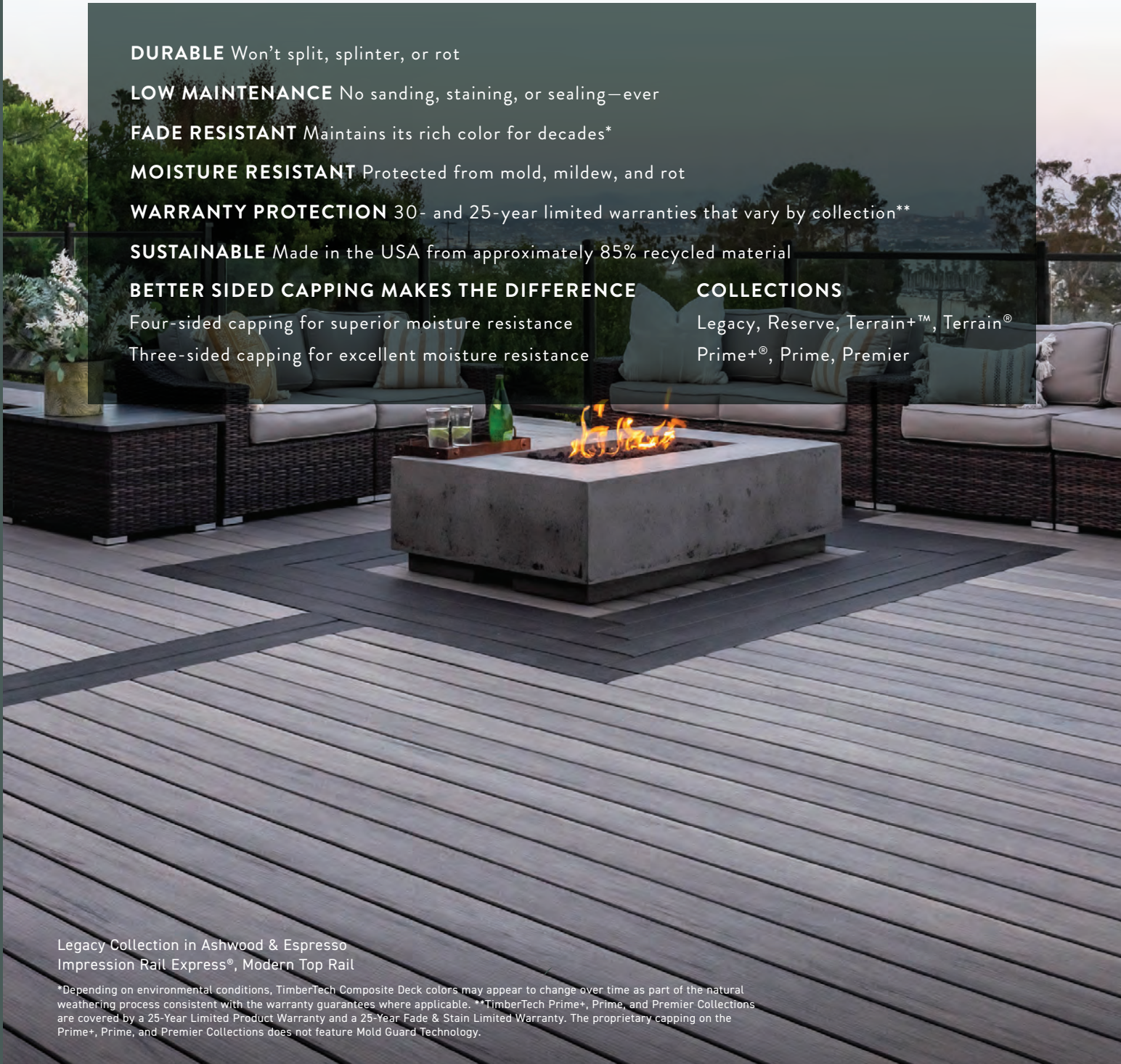

Legacy Collection in Ashwood & Espresso  
Impression Rail Express®, Modern Top Rail

\*Depending on environmental conditions, TimberTech Composite Deck colors may appear to change over time as part of the natural weathering process consistent with the warranty guarantees where applicable. \*\*TimberTech Prime+, Prime, and Premier Collections are covered by a 25-Year Limited Product Warranty and a 25-Year Fade & Stain Limited Warranty. The proprietary capping on the Prime+, Prime, and Premier Collections does not feature Mold Guard Technology.

# LEGACY COLLECTION



## Hand-Scraped Finish

Choose the Legacy Collection for an artisanal, craftsman-inspired look. With cascading hues, a textured, hand-scraped finish, and a variable grain pattern, each board is unique—perfect for clients wanting a one-of-a-kind deck.



ESPRESSO™

WHITEWASH CEDAR\*

MOCHA



PECAN

TIGERWOOD

ASHWOOD

# RESERVE COLLECTION



## Reclaimed Wood

For clients looking to capture the character-rich look and feel of reclaimed wood, go with the Reserve Collection. These boards feature bold, cascading colors, a rustic cathedral grain, and a wire-brushed finish.

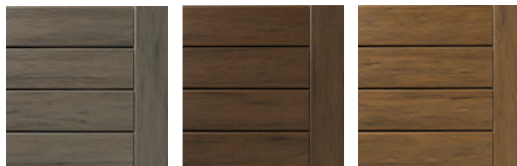

DRIFTWOOD

DARK ROAST\*

ANTIQUE LEATHER\*

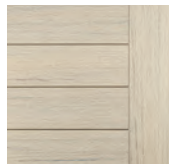

RECLAIMED CHESTNUT™

## WUI-COMPLIANT FIRE-RESISTANT SKUS

### FOR HOMES IN FIRE ZONES

The fire-resistant (FR) SKUs of the Reserve Collection are WUI-compliant, making them a better choice for fire zones.

PRODUCT DESCRIPTION	TimberTech Model Number		
	12'	16'	20'
<b>LEGACY COLLECTION</b>			
1 x 6 Grooved Espresso	LCGV5412E	LCGV5416E	LCGV5420E
1 x 6 Square-Shouldered Espresso	—	LC5416E	LC5420E
1 x 6 Grooved Whitewash Cedar	LCGV5412WC	LCGV5416WC	LCGV5420WC
1 x 6 Square-Shouldered Whitewash Cedar	—	LC5416WC	LC5420WC
1 x 6 Grooved Mocha	LCGV5412M	LCGV5416M	LCGV5420M
1 x 6 Square-Shouldered Mocha	—	LC5416M	LC5420M
1 x 6 Grooved Pecan	LCGV5412P	LCGV5416P	LCGV5420P
1 x 6 Square-Shouldered Pecan	—	LC5416P	LC5420P
1 x 6 Grooved Tigerwood	LCGV5412TW	LCGV5416TW	LCGV5420TW
1 x 6 Square-Shouldered Tigerwood	—	LC5416TW	LC5420TW
1 x 6 Grooved Ashwood	LCGV5412AW	LCGV5416AW	LCGV5420AW
1 x 6 Square-Shouldered Ashwood	—	LC5416AW	LC5420AW

<b>LEGACY FASCIA</b>			
12" Fascia Espresso	FBLC12E	—	—
12" Fascia Whitewash Cedar	FBLC12WC	—	—
12" Fascia Mocha	FBLC12M	—	—
12" Fascia Pecan	FBLC12P	—	—
12" Fascia Tigerwood	FBLC12TW	—	—
12" Fascia Ashwood	FBLC12AW	—	—

<b>LEGACY RISER</b>			
7-1/4" Riser Espresso	LCRISERE	—	—
7-1/4" Riser Whitewash Cedar	LCRISERWC	—	—
7-1/4" Riser Mocha	LCRISERM	—	—
7-1/4" Riser Pecan	LCRISERP	—	—
7-1/4" Riser Tigerwood	LCRISERTW	—	—
7-1/4" Riser Ashwood	LCRISERAW	—	—

### PROFILE OPTIONS

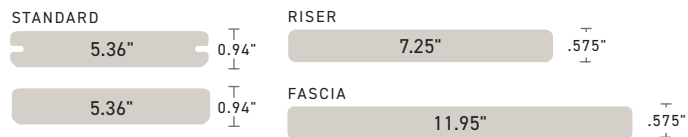

PRODUCT DESCRIPTION	TimberTech Model Number		
	12'	16'	20'
<b>RESERVE COLLECTION</b>			
1 x 6 Grooved Driftwood	RCGV5412DW	RCGV5416DW	RCGV5420DW
1 x 6 Square-Shouldered Driftwood	—	RC5416DW	RC5420DW
1 x 6 Grooved Antique Leather	RCGV5412AL	RCGV5416AL	RCGV5420AL
1 x 6 Square-Shouldered Antique Leather	—	RC5416AL	RC5420AL
1 x 6 Grooved Dark Roast	RCGV5412DR	RCGV5416DR	RCGV5420DR
1 x 6 Square-Shouldered Dark Roast	—	RC5416DR	RC5420DR
1 x 6 Grooved Reclaimed Chestnut	RCGV5412RC	RCGV5416RC	RCGV5420RC
1 x 6 Square-Shouldered Reclaimed Chestnut	—	RC5416RC	RC5420RC

<b>RESERVE FASCIA</b>			
12" Fascia Driftwood	FBRC12DW	—	—
12" Fascia Antique Leather	FBRC12AL	—	—
12" Fascia Dark Roast	FBRC12DR	—	—
12" Fascia Reclaimed Chestnut	FBRC12RC	—	—

<b>RESERVE RISER</b>			
7-1/4" Riser Driftwood	RCRISERDW	—	—
7-1/4" Riser Antique Leather	RCRISERAL	—	—
7-1/4" Riser Dark Roast	RCRISERDR	—	—
7-1/4" Riser Reclaimed Chestnut	RCRISERRC	—	—

### PROFILE OPTIONS

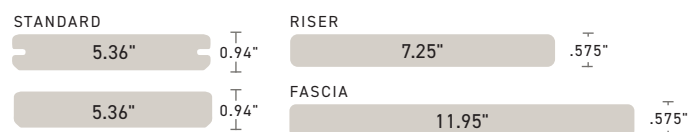

New



Terrain+ Collection in Dark Oak, Classic Composite Series with Premier Top Rail

# TERRAIN+ COLLECTION™



## Subtle Wood Grain

For clients that want maximum style for their dollar, we offer the new Terrain+ Collection. It features the same lightweight, scalloped profile, but with an updated color palette. Thanks to new and improved color blending technology, these boards deliver sophisticated colors with a subtle grain pattern like sanded White oak and walnut for a versatile, natural wood look.

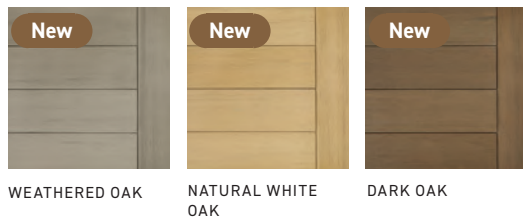

WEATHERED OAK

NATURAL WHITE OAK

DARK OAK

PRODUCT DESCRIPTION	TimberTech Model Number		
	12'	16'	20'
<b>TERRAIN+ COLLECTION</b>			
1 x 6 Grooved Natural White Oak	TCGV5412NW	TCGV5416NW	TCGV5420NW
1 x 6 Square-Shouldered Natural White Oak	—	TC5416NW	TC5420NW
1 x 6 Grooved Weathered Oak	TCGV5412WO	TCGV5416WO	TCGV5420WO
1 x 6 Square-Shouldered Weathered Oak	—	TC5416WO	TC5420WO
1 x 6 Grooved Dark Oak	TCGV5412DO	TCGV5416DO	TCGV5420DO
1 x 6 Square-Shouldered Dark Oak	—	TC5416DO	TC5420DO
<b>TERRAIN+ FASCIA</b>			
12" Fascia Natural White Oak	FBTC12NW	—	—
12" Fascia Weathered Oak	FBTC12WO	—	—
12" Fascia Dark Oak	FBTC12DO	—	—
<b>TERRAIN+ RISER</b>			
7-1/4" Riser Natural White Oak	TCRISERNW	—	—
7-1/4" Riser Weathered Oak	TCRISERWO	—	—
7-1/4" Riser Dark Oak	TCRISERDO	—	—

### PROFILE OPTIONS

#### STANDARD



#### RISER

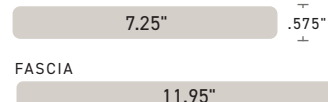

#### FASCIA



# TERRAIN® COLLECTION



## Rugged Cathedral Grain

Embrace a timeless, authentic wood look with the subtle coloring and rugged cathedral grain of the Terrain Collection. Clients can choose from boards with varied color blending or those with a solid, stained wood look. Plus, with their scalloped profile, these boards are lighter in weight for easier installation.



BROWN OAK

SILVER MAPLE

For additional colors, visit [TimberTech.com](http://TimberTech.com).

PRODUCT DESCRIPTION	TimberTech Model Number		
	12'	16'	20'
<b>TERRAIN COLLECTION™</b>			
1 x 6 Grooved Brown Oak	TCGV5412B0	TCGV5416B0	TCGV5420B0
1 x 6 Square-Shouldered Brown Oak	—	TC5416B0	TC5420B0
1 x 6 Grooved Silver Maple	TCGV5412SM	TCGV5416SM	TCGV5420SM
1 x 6 Square-Shouldered Silver Maple	—	TC5416SM	TC5420SM
<b>TERRAIN FASCIA</b>			
12" Fascia Brown Oak	FBTC12B0	—	—
12" Fascia Silver Maple	FBTC12SM	—	—
<b>TERRAIN RISER</b>			
7-1/4" Riser Brown Oak	TCRISERB0	—	—
7-1/4" Riser Silver Maple	TCRISERSM	—	—

### PROFILE OPTIONS

#### STANDARD



#### RISER



#### FASCIA



# PREMIER COLLECTION\*



## Painted Wood

For an opaque stained or painted wood look in a solid-profile board, introduce clients to the Premier Collection, which features earthy, vivid wood stain colors and a subtle straight grain pattern.



MARITIME GRAY™

DARK TEAK™

Availability varies by region.

PRODUCT DESCRIPTION	TimberTech Model Number		
	12'	16'	20'
<b>PREMIER COLLECTION</b>			
1 x 6 Grooved Dark Teak	EFGV5412DT	EFGV5416DT	EFGV5420DT
1 x 6 Square-Shouldered Dark Teak	—	EF5416DT	EF5420DT
1 x 6 Grooved Maritime Gray	EFGV5412MG	EFGV5416MG	EFGV5420MG
1 x 6 Square-Shouldered Maritime Gray	—	EF5416MG	EF5420MG
<b>PREMIER FASCIA</b>			
12" Fascia Dark Teak	FBE12DT	—	—
12" Fascia Maritime Gray	FBE12MG	—	—
<b>PREMIER RISER</b>			
7-1/4" Riser Dark Teak	ERISERDT	—	—
7-1/4" Riser Maritime Gray	ERISERMG	—	—

### PROFILE OPTIONS

#### STANDARD



#### RISER

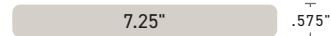

#### FASCIA



Square-Shouldered boards are WUI-Compliant.

\*TimberTech Prime+, Prime, and Premier Collections are covered by a 25-Year Limited Product Warranty and a 25-Year Fade & Stain Limited Warranty. The proprietary capping on the Prime+, Prime, and Premier Collections does not feature Mold Guard Technology. Availability varies by region.

# PRIME+ COLLECTION®\*



## Timeless Wood Grain

Opt for a simple, traditional wood look with the natural, inviting colors and textured straight grain pattern of the Prime+ Collection. The authentic wood styling, minimal maintenance needs, and attainable price point make this collection the ideal choice for clients looking to upgrade from wood.



COCONUT HUSK® SEA SALT GRAY DARK COCOA

PRODUCT DESCRIPTION	TimberTech Model Number		
	12'	16'	20'
<b>PRIME+ COLLECTION</b>			
1 x 6 Grooved Coconut Husk	PRGV5412CH	PRGV5416CH	PRGV5420CH
1 x 6 Square-Shouldered Coconut Husk	—	PR5416CH	PR5420CH
1 x 6 Grooved Sea Salt Gray	PRGV5412ST	PRGV5416ST	PRGV5420ST
1 x 6 Square-Shouldered Sea Salt Gray	—	PR5416ST	PR5420ST
1 x 6 Grooved Dark Cocoa	PRGV5412DC	PRGV5416DC	PRGV5420DC
1 x 6 Square-Shouldered Dark Cocoa	—	PR5416DC	PR5420DC
<b>PRIME+ FASCIA</b>			
12" Fascia Coconut Husk	FBE12CH	—	—
12" Fascia Sea Salt Gray	FBE12ST	—	—
12" Fascia Dark Cocoa	FBE12DC	—	—
<b>PRIME+ RISER</b>			
7-1/4" Riser Coconut Husk	ERISERCH	—	—
7-1/4" Riser Sea Salt Gray	ERISERST	—	—
7-1/4" Riser Dark Cocoa	ERISERDC	—	—

### PROFILE OPTIONS

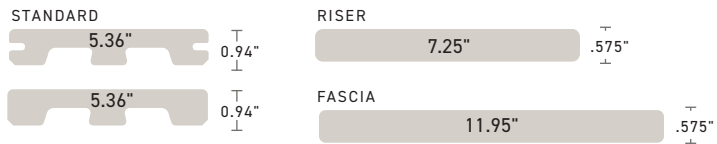

# PRIME COLLECTION™



## Painted Wood

The Prime Collection features the same colors as the Premier Collection, but with a scalloped board for a lighter weight without compromising a secure underfoot feel.

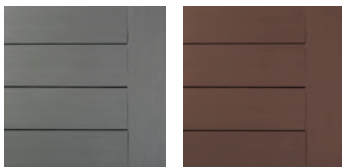

MARITIME GRAY™ DARK TEAK™

PRODUCT DESCRIPTION	TimberTech Item Number		
	12'	16'	20'
<b>PRIME COLLECTION</b>			
1 x 6 Grooved Dark Teak	ESGV5412DT	ESGV5416DT	ESGV5420DT
1 x 6 Square-Shouldered Dark Teak	—	ES5416DT	ES5420DT
1 x 6 Grooved Maritime Gray	ESGV5412MG	ESGV5416MG	ESGV5420MG
1 x 6 Square-Shouldered Maritime Gray	—	ES5416MG	ES5420MG
<b>PRIME FASCIA</b>			
12" Fascia Dark Teak	FBE12DT	—	—
12" Fascia Maritime Gray	FBE12MG	—	—
<b>PRIME RISER</b>			
7-1/4" Riser Dark Teak	ERISERDT	—	—
7-1/4" Riser Maritime Gray	ERISERMG	—	—

### PROFILE OPTIONS

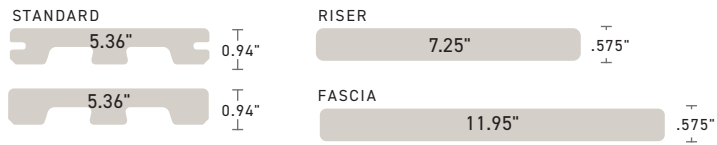

\*TimberTech Prime+, Prime, and Premier Collections are covered by a 25-Year Limited Product Warranty and a 25-Year Fade & Stain Limited Warranty. \*The proprietary capping on the Prime+, Prime, and Premier Collections does not feature Mold Guard Technology.

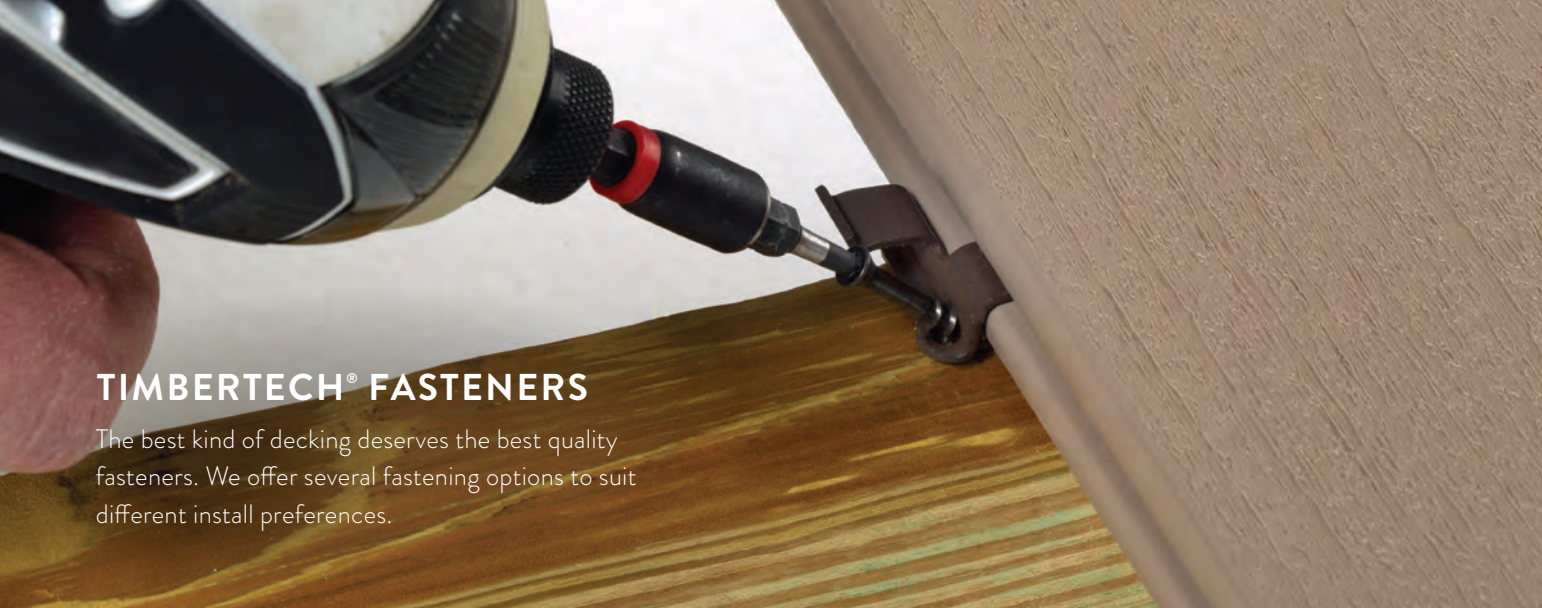

## TIMBERTECH® FASTENERS

The best kind of decking deserves the best quality fasteners. We offer several fastening options to suit different install preferences.

### TOPLOC® FOR ADVANCED PVC

Top-down, complementary color decking fasteners.



- Top-down, stainless steel fasteners with hand-painted, coordinated color heads to complement TimberTech Advanced PVC colors
- 305-grade stainless steel screws, ACQ-approved, with TORX® ttap® drive for wobble-free installation
- Compatible with all TimberTech Advanced PVC boards except MAX.

PRODUCT DESCRIPTION	TimberTech Model Number	
	100 SQ FT	300 SQ FT
<b>TOPLOC FOR ADVANCED PVC</b>		
2½" TOPLoc Screws Brown	ATLOC100B	ATLOC300B
2½" TOPLoc Screws Dark Brown	ATLOC100DB	ATLOC300DB
2½" TOPLoc Screws Light Tan	ATLOC100LT	ATLOC300LT
2½" TOPLoc Screws Light Gray	ATLOC100LG	ATLOC300LG
2½" TOPLoc Screws Dark Gray	ATLOC100DG	ATLOC300DG

### TOPLOC® FOR ADVANCED PVC FASCIA

Top-down, complementary color fasteners designed for fascia boards.



- Top-down, stainless steel fasteners with hand-painted, coordinated color heads to complement TimberTech Advanced PVC fascia colors
- 305-grade stainless steel screws, ACQ-approved, with TORX ttap drive for wobble-free installation
- Compatible with all TimberTech Advanced PVC fascia boards

PRODUCT DESCRIPTION	TimberTech Model Number	
	30 LIN FT	
<b>TOPLOC FASCIA FOR ADVANCED PVC</b>		
1" TOPLoc Fascia Screws Brown 100/Pkg	ATLOCFAS30B	
1" TOPLoc Fascia Screws Dark Brown 100/Pkg	ATLOCFAS30DB	
1" TOPLoc Fascia Screws Light Tan 100/Pkg	ATLOCFAS30LT	
1" TOPLoc Fascia Screws Light Gray 100/Pkg	ATLOCFAS30LG	
1" TOPLoc Fascia Screws Dark Gray 100/Pkg	ATLOCFAS30DG	

**Colors:**  
TOPLoc for TimberTech  
Advanced PVC Decking &  
Fascia

**Brown:** Mahogany, English Walnut®  
**Dark Brown:** Kona®, Dark Hickory, American Walnut™  
**Light Gray:** Slate Gray, Coastline®, Boardwalk®

**Dark Gray:** Castle Gate™  
**Light Tan:** Weathered Teak®, French White Oak®, Brownstone  
**Tan:** Cypress®

## TOPLOC® FOR COMPOSITE

Top-down, complementary color decking fasteners.

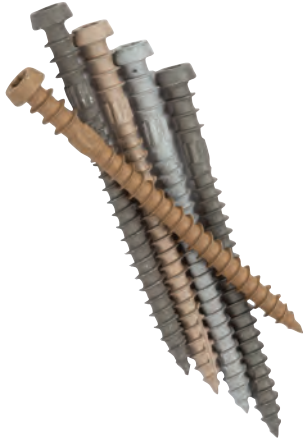

- Top-down, carbon steel or stainless steel fasteners coated with select colors to complement TimberTech Composite Decking
- Designed for dense composite material using an 18v drill or higher drill driver set at high speed for maximum performance
- Compatible with all TimberTech Composite Decking boards

PRODUCT DESCRIPTION	TimberTech Model Number		
	85 SQ FT	100 SQ FT	500 SQ FT
<b>TOPLOC FOR COMPOSITE</b>			
2½" TOPLoc Screws Ivory	—	TLOC350I	TLOC1750I
2½" TOPLoc Screws Cedar	—	TLOC350C	TLOC1750C
2½" TOPLoc Screws Sand	—	TLOC350S	TLOC1750S
2½" TOPLoc Screws Teak	—	TLOC350T	TLOC1750T
2½" TOPLoc Screws Walnut	—	TLOC350W	TLOC1750W
2½" TOPLoc Screws Light Gray	—	TLOC350LG	TLOC1750LG
2½" TOPLoc Screws Gray	—	TLOC350G	TLOC1750G
2½" TOPLoc Screws Dark Gray	—	TLOC350DG	TLOC1750DG
3" TOPLoc SS Screws Ivory	TLOC300SSI	—	—
3" TOPLoc SS Screws Cedar	TLOC300SSC	—	—
3" TOPLoc SS Screws Sand	—	—	TLOC1750S
3" TOPLoc SS Screws Teak	TLOC300SST	—	—
3" TOPLoc SS Screws Walnut	TLOC300SSW	—	—
3" TOPLoc SS Screws Light Gray	TLOC300SSLG	—	—
3" TOPLoc SS Screws Gray	TLOC300SSG	—	—
3" TOPLoc SS Screws Dark Gray	TLOC300SSDG	—	—

## TOPLOC® FOR COMPOSITE FASCIA

Top-down, complementary color fasteners designed for fascia boards.



- Top-down, stainless steel fasteners coated with select colors to complement TimberTech Composite Decking fascia and riser boards
- Designed to decrease unsightly oil-canning
- Compatible only with all TimberTech Composite Decking fascia boards

PRODUCT DESCRIPTION	TimberTech Model Number
<b>TOPLOC FASCIA FOR COMPOSITE</b>	
1½" TOPLoc Fascia Screws Ivory 100/Pkg	TLOCFAS100I
1½" TOPLoc Fascia Screws Cedar 100/Pkg	TLOCFAS100C
1½" TOPLoc Fascia Screws Sand 100/Pkg	TLOCFAS100S
1½" TOPLoc Fascia Screws Teak 100/Pkg	TLOCFAS100T
1½" TOPLoc Fascia Screws Walnut 100/Pkg	TLOCFAS100W
1½" TOPLoc Fascia Screws Light Gray 100/Pkg	TLOCFAS100LG
1½" TOPLoc Fascia Screws Gray 100/Pkg	TLOCFAS100G
1½" TOPLoc Fascia Screws Dark Gray 100/Pkg	TLOCFAS100DG
TOPLoc Fascia Drill Bit	TLOCFASBIT

**Colors:**  
TOPLoc for TimberTech  
Composite Decking  
& Fascia

**Light Gray:** Sea Salt Gray

**Gray:** Gray\*, Maritime Gray™, Driftwood,  
Weathered Oak

**Dark Gray:** Silver Maple, Ashwood, Espresso™

**Teak:** Antique Leather®, Pecan, Tigerwood,  
Coconut Husk®

**Walnut:** Brown Oak, Dark Oak, Dark Roast®,  
Mocha, Dark Cocoa

**Ivory:** Whitewash Cedar®

**Sand:** Cedar\*, Natural White Oak,  
Reclaimed Chestnut™

**Stainless Steel:** Cedar\*

\*Color-matched to ReliaBoard®



## FUSIONLOC®

Collated metal clips and screws provide three points of board-to-joist connection for a secure hold and a hidden appearance.



- Collated hidden fastener system engineered for strength and speed of installation
- Offers a pneumatic installation with the FastenMaster FiveShot Tool or manual installation using the FUSIONLoc Hand Driven Guide
- Compatible with all TimberTech grooved boards

PRODUCT DESCRIPTION	TimberTech Model Number
<b>FUSIONLOC FOR ADVANCED PVC &amp; COMPOSITE</b>	
FUSIONLoc 225 SF/Pkg (Pneumatic)	FLOC225
FUSIONLoc 450 SF/Pkg (Pneumatic)	FLOC450
FUSIONLoc Hand Driven Guide	FLOCHDGUIDE
FUSIONLoc 50 SF/Pkg (Hand Driven)	FLOCHD50
FUSIONLoc 225 SF/Pkg (Hand Driven)	FLOCHD225

## CONCEALOC®

Clips with a matte brown finish secured to joists with screws in between grooved boards for a hidden appearance.



- Hidden fastener system that can be installed pneumatically with the FastenMaster Tiger Claw Gun or using a drill or hand driven using a drill driver
- Stainless steel clips and screws for long-term performance
- Compatible with all TimberTech grooved deck boards

PRODUCT DESCRIPTION	TimberTech Model Number
<b>CONCEALOC FOR ADVANCED PVC &amp; COMPOSITE</b>	
CONCEALoc 100 SF/ Carton Clips and Screws	CLOCFAST
CONCEALoc 500 SF/Pkg Gun Pail Clips and Screws for Pneumatic	CLOGUNPAIL
CONCEALoc 1000 SF/Bucket Clips and Screws	CLOCBULK
CONCEALoc L-Bracket 50/Pk Brackets and Screws	CLOCLBKT
CONCEALoc Router Bit	CLOCRBIT
CONCEALoc Replacement Screws, 50 Screws	CLOCSCREW

## SIDELoc™

Screws installed at an angle through the side of the board and into the joist with the SIDELoc guide for a secure hold and discreet spacing.



- Hidden fastener system with superior holding power that requires no pre-drilling
- Stainless steel composition resists screw shear and installs creating a 1/8" gap
- Compatible with only TimberTech Advanced PVC Square-Shouldered deck boards
- Not for use with TimberTech Composite or any grooved profile deck boards

PRODUCT DESCRIPTION	TimberTech Model Number		
	100 SQ FT	200 SQ FT	500 SQ FT
<b>SIDELoc FOR ADVANCED PVC</b>			
1" SIDELoc 304 Stainless Steel Screws	SLOC100SF188	SLOC200SF188	SLOC500SF188
2" SIDELoc 316 Marine Grade SS Screws	SLOC100SF238MG	SLOC200SF238MG	SLOC500SF238MG
<b>TOOLS AND ACCESSORIES</b>			
SIDELoc 3" Driver Bits (set of 2)	SLOCBIT		
SIDELoc 5 1/2" Guide for standard width Advanced PVC Deck	SLOCGUIDE		
SIDELoc 3 1/2" Guide for narrow width Advanced PVC Deck	SLOC350GUIDE		
SIDELoc 7 1/2" Extension for wide width Advanced PVC Deck	SLOC725EXT		

## EDGELOC®

Nylon 12-clip collated strips & pre-set stainless steel screws provide a consistent 7/32" gap.



- Clip has strong lateral hold to engage the board well
- Easy-to-use, 12-clip collated strip with pre-set screws reduces installation time
- Compatible with TimberTech Prime+, Prime & Premier grooved boards
- Not for use with TimberTech Advanced PVC or TimberTech Composite in the following collections: Terrain, Terrain+, Reserve, or Legacy

PRODUCT DESCRIPTION	TimberTech Model Number		
	55 SQ FT	250 SQ FT	DISPLAY
<b>EDGELOC FOR COMPOSITE</b>			
EDGELOC Hidden Fasteners	ELOC55	ELOC250	
EDGELOC Display (including clips)			ELOCBULK

# CORTEX® FOR ADVANCED PVC DECKING

Top-down fastener with complementary color plugs made of the same decking as the surface boards to completely blend in.



- A top-down hidden fastener system that features a high-quality, ACQ-approved specialty deck screw with a TORX ttap drive system
- Complementary color plugs made from the TimberTech deck boards of your choice to hide the fastener
- Compatible with all TimberTech full-profile deck boards

PRODUCT DESCRIPTION	TimberTech Model Number			
	100 SQ FT	300 SQ FT	100 SQ FT COLLATED	300 SQ FT COLLATED
<b>CORTEX FOR ADVANCED PVC</b>				
Cortex Screws - Brownstone	CTX100SFBS	CTX300SFBS	CTC100SFBS	CTC300SFBS
Cortex Screws - Kona	CTX100SFKO	CTX300HCKOAAAT	CTC100SFKO	CTC300SFKO
Cortex Screws - Slate Gray	CTX100SFSG	CTX300SFSG	CTC100SFSG	CTC300SFSG
Cortex Screws - American Walnut	—	—	CTC100SFAW	CTC300SFAW
Cortex Screws - French White Oak	CTC100SFFW	CTC300SFFW	—	—
Cortex Screws - Castle Gate	—	—	CTC100SFCG	CTC300SFCG
Cortex Screws - Boardwalk	—	—	CTC100SFBW	CTC300SFBW
Cortex Screws - Coastline	CTX100SFCS	CTX300SFCS	CTC100SFCS	CTC300SFCS
Cortex Screws - Dark Hickory	CTX100SFDH	CTX300SFDH	CTC100SFDH	CTC300SFDH
Cortex Screws - English Walnut	CTX100SFEW	CTX300SFEW	CTC100SFEW	CTC300SFEW
Cortex Screws - Mahogany	CTX100SFMH	CTX300SFMH	CTC100SFMH	CTC300SFMH
Cortex Screws - Weathered Teak	CTX100SFWT	CTX300SFWT	CTC100SFWT	CTC300SFWT
Cortex Screws - Cypress	CTX100SFCY	CTX300SFCY	CTC100SFCY	CTC300SFCY
<b>CORTEX FOR ADVANCED PVC MAX</b>				
Cortex Screws - Slate Gray - ADVANCED PVC MAX			CTCM100SFSG	
Cortex Screws - Coastline - ADVANCED PVC MAX			CTCM100SFCS	



PRODUCT DESCRIPTION	TimberTech Model Number	
	Collated Cortex 40 Plug Pack (no bit)	Collated Cortex 400 Plug Pack (1 bit)
<b>CORTEX PLUG PACKS (SCREWS SOLD SEPARATELY)</b>		
Harvest Brownstone	CTC40PCBS	CTC400PCBS
Harvest Kona	CTC40PCKO	CTC400PCKO
Harvest Slate Gray	CTC40PCSG	CTC400PCSG
Harvest MAX Slate Gray	—	CTCM400PCSG
Landmark American Walnut	CTC40PCAW	CTC400PCAW
Landmark French White Oak	CTC40PCFW	CTC400PCFW
Landmark Castle Gate	CTC40PCCG	CTC400PCCG
Landmark Boardwalk	—	CTC400PCBD
Vintage Coastline	CTC40PCCS	CTC400PCCS
Vintage Dark Hickory	CTC40PCDH	CTC400PCDH
Vintage English Walnut	CTC40PCEW	CTC400PCEW
Vintage Mahogany	CTC40PCMH	CTC400PCMH
Vintage Cypress	—	CTC400PCCY
Vintage Weathered Teak	CTC40PCWT	CTC400PCWT
<b>CORTEX SPECIALTY SCREWS (PLUGS SOLD SEPARATELY)</b>		
Cortex 316 Stainless Steel 100 SQ FT (350 screws, 1 bit)	CTS350SS25	
Cortex for Decking as Cladding 100 SQ FT (365 screws, 1 bit)	CTS350CS2	
NEW! Cortex Aluminum Driller 100 SQ FT (350 screws, 1 bit)	CTS350AD158	

# CORTEX® FOR COMPOSITE DECKING

Top-down fastener with color-matched plugs made from TimberTech deck boards for the ultimate fastener-free surface – now available in collated plugs.



PRODUCT DESCRIPTION	TimberTech Model Number		
	100 LIN FT	100 LIN FT COLLATED	300 LIN FT COLLATED
<b>CORTEX FOR COMPOSITE</b>			
Cortex Screws - Dark Teak	CTX100EDT	—	—
Cortex Screws - Maritime Gray	CTX100EMG	—	—
Cortex Screws - Ashwood	CTX100CAW	CTC100LFAW	CTC300SFAW
Cortex Screws - Espresso	CTX100LCE	CTC100LFWC	CTC300SFWC
Cortex Screws - Mocha	CTX100LCM	CTC100LFM	CTC300SFM
Cortex Screws - Pecan	CTX100LCP	CTC100LFP	CTC300SFP
Cortex Screws - Tigerwood	CTX100LCTW	CTC100LFTW	CTC300SFTW
Cortex Screws - Whitewash Cedar	CTX100LCWC	CTC100LFWC	CTC300SFWC
Cortex Screws - Antique Leather	CTX100RCAL	CTC100LFAL	CTC300SFAL
Cortex Screws - Dark Roast	CTX100RCDR	CTC100LFDR	CTC300SFDR
Cortex Screws - Driftwood	CTX100RCDW	CTC100LFDW	CTC300SFDW
Cortex Screws - Reclaimed Chestnut	CTX100RCRC	CTC100LFRC	CTC300SFRC



PRODUCT DESCRIPTION	TimberTech Model Number	
	Cortex 40 Plug Pack (no bit)	Cortex 400 Plug Pack (1 bit)
<b>CORTEX PLUG PACKS (SCREWS SOLD SEPARATELY)</b>		
Premier Dark Teak	CTX40PCDT	CTX400PCDT
Premier Maritime Gray	CTX40PCMG	CTX400PCMG
Reserve Driftwood	CTX40PCDW	CTX400PCDW
Reserve Antique Leather	CTX40PCAL	CTX400PCAL
Reserve Dark Roast	CTX40PCDR	CTX400PCDR
Reserve Reclaimed Chestnut	—	CTX400PCRC
Legacy Ashwood	CTX40PCAW	CTX400PAW
Legacy Espresso	CTX40PCE	CTX400PCE
Legacy Mocha	CTX40PCM	CTX400PCM
Legacy Pecan	CTX40PCP	CTX400PCP
Legacy Tigerwood	CTX40PCTW	CTX400PCTW
Legacy Whitewash Cedar	CTX40PCWC	CTX400PCWC

**TimberTech**  
**R A I L I N G**  
 BY **AZEK**



Vintage Collection® in Coastline, RadianceRail® Express

The TimberTech Railing portfolio delivers enduringly beautiful designs as well as superior performance, whether choosing from our composite, PVC, or metal railing collections. Plus, lots of customization options mean it's easy to create a unique look.

## COMPOSITE RAILING

A mix of high-performance polymers and recycled wood fibers for impressive durability, this collection offers the most customization and style options

**HIGHLY DURABLE** Resists cracking, splitting, and splintering

**MOISTURE RESISTANT** Protected from mold, mildew & rot

**PREMIUM MATTE COLORS** Protected by 25-year Limited Fade & Stain Warranty

**RESEMBLES THE LOOK OF PAINTED WOOD**

**LOW MAINTENANCE** Never needs painting or staining

**MADE FROM UP TO 50% RECYCLED MATERIAL**

**OFFERS THE MOST CUSTOMIZATIONS & STYLES** From modern to traditional



## PVC RAILING

Extruded PVC material with aluminum reinforcement for exceptional performance, this collection has elevated design potential

### BEST MOISTURE RESISTANCE & DURABILITY

Won't crack, rot, split, or peel

### UV-RESISTANT FOR COLOR PROTECTION

### LIGHTWEIGHT FOR EASIER HANDLING

**PAINTABLE FOR A CUSTOM LOOK** But not required

### MILLED-WOOD-INSPIRED DESIGNS

**ELEVATED DESIGN POTENTIAL** Crisp corners, tight, clean lines



Pinnacle Rail with Square Web Decorative Panel

## METAL RAILING

Powder-coated aluminum for high performance and corrosion resistance, the panelized railing system in this collection makes it easy to install

**SUPERIOR DURABILITY** Won't crack, rot, split, or peel

**MOISTURE RESISTANT** Resists rotting and cracking

**NARROWER BALUSTERS FOR A LESS OBSTRUCTED VIEW**

(up to 30% less than competitors)

**PANELIZED RAILING SYSTEM FOR A QUICK INSTALL**

(no fastening of individual balusters)

**WROUGHT-IRON-INSPIRED AESTHETICS**

**SLEEK TOP RAIL OPTIONS WITH NO VISIBLE HARDWARE**



Impression Rail Express® in Black  
Vintage Collection® in Weathered Teak®

TIMBERTECH®  
COMPOSITE RAILING



Unlimited design options backed  
by unbeatable warranties



Classic Composite Series Drink Rail  
Vintage Collection® in English Walnut® and Dark Hickory

# CLASSIC COMPOSITE SERIES

With several top rails and a universal bottom rail, the Classic Composite Series offers the most customization options, making mixing and matching components a breeze.

## TOP RAIL PROFILES



**DRINK RAIL**

*Compatible with full profile, Square-Shouldered boards. Not compatible with glass infill.*



**RADIANCERAIL®**



**PREMIER RAIL™**



**TRADEMARK RAIL™**

*Only available in White and Matte White.*



## INFILL OPTIONS



**SOLID COMPOSITE BALUSTER**

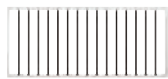

**ALUMINUM**



**GLASS**

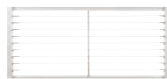

**CABLERRAIL**

## COLOR OPTIONS



**GLOSS WHITE**



**MATTE WHITE**



**MATTE ESPRESSO**



**MATTE BLACK**

Matte colors also include a 25-Year Fade & Stain Limited Warranty



Classic Composite Series Drink Rail  
Landmark Collection® in French White Oak®

# CLASSIC COMPOSITE SERIES KITS, PACKS, AND TOP RAILS

Single universal bracket for level, stairs & angles

PRODUCT DESCRIPTION	TimberTech Model Number			
	White	Matte White	MATTE ESPRESSO	MATTE BLACK
<b>UNIVERSAL RAIL KITS</b> - Kits Include 1 Universal Rail, 2 Support Rails, Hardware, Footblocks, and 13 Balusters for 6', 18 Balusters for 8'				
6' Universal Rail Kit	TCU36KIT6W	TCU36KIT6MW	—	—
8' Universal Rail Kit	TCU36KIT8W	TCU36KIT8MW	—	—
<b>UNIVERSAL RAIL PACKS</b> - Packs Include 1 Universal Rail, 2 Support Rails, Hardware, and Footblocks				
6' Universal Rail Pack	TCURP6W	TCURP6MW	TCURP6ME	TCUR06MB
8' Universal Rail Pack	TCURP8W	TCURP8MW	TCURP8ME	TCURP8MB
10' Universal Rail Pack	TCURP10W	TCURP10MW	—	TCURP10MB
6' Custom Universal Rail Pack - Laser Etched	TCURPCUST6W	TCURPCUST6MW	TCURPCUST6ME	TCURPCUST6MB
8' Custom Universal Rail Pack - Laser Etched	TCURPCUST8W	TCURPCUST8MW	TCURPCUST8ME	TCURPCUST8MB
10' Custom Universal Rail Pack - Laser Etched	TCURPCUST10W	TCURPCUST10MW	—	TCURPCUST10MB
<b>PREMIER TOP RAIL</b>				
6' Premier Top Rail	APTR6W	APTR6MW	APTR6ME	APTR6MB
8' Premier Top Rail	APTR8W	APTR8MW	APTR8ME	APTR8MB
10' Premier Top Rail	APTR10W	APTR10MW	—	APTR10MB
<b>RADIANCE RAIL TOP RAIL</b>				
6' RadianceRail Top Rail	TRRTR06W	TRRTR06MW	TRRTR06ME	TRRTR06MB
8' RadianceRail Top Rail	TRRTR08W	TRRTR08MW	TRRTR06ME	TRRTR08MB
10' RadianceRail Top Rail	TRRTR10W	TRRTR10MW	—	TRRTR10MB
<b>TRADEMARK TOP RAIL</b>				
6' Trademark Top Rail	ATTR6W	ATTR6MW	—	—
8' Trademark Top Rail	ATTR8W	ATTR8MW	—	—
10' Trademark Top Rail	ATTR10W	ATTR10MW	—	—
<b>DRINK RAIL (UNIVERSAL RAIL)</b> - Includes Undrilled Rail and Hardware to attach deck board				
6' Universal Rail	UDCUSTCUBR6W	UDCUSTCUBR6MW	UDCUSTCUBR6ME	UDCUSTCUBR6MB
8' Universal Rail	UDCUSTCUBR8W	UDCUSTCUBR8MW	UDCUSTCUBR8ME	UDCUSTCUBR8MB
10' Universal Rail	UDCUSTCUBR10W	UDCUSTCUBR10MW	—	UDCUSTCUBR10MB

## CLASSIC COMPOSITE INFILLS

PRODUCT DESCRIPTION	TimberTech Model Number			
	White	Matte White	MATTE ESPRESSO	MATTE Black
<b>COMPOSITE BALUSTERS - 18/Pack</b>				
29" Square Composite Balusters	AZT29BALW	AZT29BALMW	AZT29BALME	AZT29BALMB
31" Square Composite Balusters	AZT31BALW	AZT31BALMW	AZT31BALME	AZT31BALMB
35" Square Composite Balusters	AZT35BALW	AZT35BALMW	AZT35BALME	AZT35BALMB
37" Square Composite Balusters	AZT37BALW	AZT37BALMW	AZT37BALME	AZT37BALMB
<b>ALUMINUM BALUSTERS - 20/Pack</b>				
	ROUND ALUMINUM	ROUND STAIR ALUMINUM	SQUARE ALUMINUM	SQUARE STAIR ALUMINUM
29" Use with 36" Rail	AZT29RABALB	—	AZT29SABALB	—
31" Use with 36" Rail	AZT31RABALB	AZT31RASTAIRBALB	AZT31SABALB	AZT31SASTAIRBALB
35" Use with 42" Rail	AZT35RABALB	—	AZT35SABALB	—
37" Use with 42" Rail	AZT37RABALB	AZT37RASTAIRBALB	AZT37SABALB	AZT37SASTAIRBALB

- Required number of Balusters for Composite: 23 per 10' section, 18 per 8' section, 13 per 6' section.
- Required number of Balusters for Aluminum: 25 per 10' section, 20 per 8' section, 15 per 6' section.



## CLASSIC COMPOSITE INFILLS (CONTINUED)

	TimberTech Model Number
<b>CABLERAIL KITS</b>	
36" CableRail Hardware Kit - 9 Quick-Connect Fittings, 9 Quick-Connect Swivel Fittings, 18 Hanger Bolts, 9 Lock Nuts	AZTCR36HWKIT
42" CableRail Hardware Kit - 11 Quick-Connect Fittings, 11 Quick-Connect Swivel Fittings, 22 Hanger Bolts, 11 Lock Nuts	AZTCR42HWKIT
36" CableRail Intermediate Baluster - 9-Hole Baluster, Intermediate Base Plate, #10X2" Pan Head Screw, (3) #10X1" Flat Head Screws	AZTCR36BAL
42" CableRail Intermediate Baluster - 11-Hole Baluster, Intermediate Base Plate, #10X2" Pan Head Screw, (3) #10X1" Flat Head Screws	AZTCR42BAL
36" CableRail Stair Intermediate Baluster - Angled 9-Hole Baluster, Intermediate Base Plate, #10X2" Pan Head Screw, (3) #10X1" Flat Head Screws	AZTCR36STAIRBAL
42" CableRail Stair Intermediate Baluster - Angled 11-Hole Baluster, Intermediate Base Plate, #10X2" Pan Head Screw, (3) #10X1" Flat Head Screws	AZTCR42STAIRBAL
CableRail 100' Stainless Steel Cable	AZTCR100CABLE
CableRail 500' Stainless Steel Cable	AZTCR500CABLE
CableRail Accessory Kit	AZTCRACCKIT
CableRail Cutter	AZTCRCUTTER
CableRail Protector Sleeves (20/Pg)	AZTCRSLEEVE
CableRail SteelRenewal™ SteelProtect™ Combo	AZTCRSRSPC
<b>GLASS CHANNEL KITS</b>	
6' Glass Channel Kit White - Glass Panel Sourced Locally	AZTGLASS6W
6' Glass Channel Kit Black - Glass Panel Sourced Locally	AZTGLASS6B

## CLASSIC COMPOSITE POST SLEEVES, CAPS, SKIRTS

PRODUCT DESCRIPTION	TimberTech Model Number			
	White	Matte White	MATTE ESPRESSO	MATTE Black
<b>POST SLEEVES</b>				
4" x 4" x 39" Post Sleeve	AZT4X4PCV39W	AZT4X4PCV39MW	AZT4X4PCV39ME	AZT4X4PCV39MB
4" x 4" x 96" Post Sleeve	AZT4X4PCV96W	AZT4X4PCV96MW	AZT4X4PCV96ME	AZT4X4PCV96M
5" x 5" x 42" Post Sleeve	T5X5PCV42W	T5X5PCV42MW	T5X5PCV42ME	T5X5PCV42MB
5" x 5" x 144" Post Sleeve	T5X5PCV144W	T5X5PCV144MW	T5X5PCV144ME	T5X5PCV144MB
5.5" x 5.5" x 39" Post Sleeve	A55X55PCV39W	A55X55PCV39MW	A55X55PCV39ME	A55X55PCV39MB
5.5" x 5.5" x 54" Post Sleeve	A55X55PCV54W	A55X55PCV54MW	A55X55PCV54ME	A55X55PCV54MB
5.5" x 5.5" x 144" Post Sleeve	A55X55PCV144W	A55X55PCV144MW	A55X55PCV144ME	A55X55PCV144MB
6" x 6" Post Sleeve	A6X6PCV108W	—	—	—
<b>POST CAPS AND SKIRTS</b>				
4" x 4" Post Cap	TX4X4PCAPW	TX4X4PCAPMW	TX4X4PCAPME	TX4X4PCAPMB
4" x 4" Island Cap	TX4X4ICAPW	TX4X4ICAPMW	TX4X4ICAPME	TX4X4ICAPMB
4" x 4" Post Skirt	AZT4X4PSKIRTW	AZT4X4PSKIRTMW	AZT4X4PSKIRTME	AZT4X4PSKIRTMB
5" x 5" Post Cap	T5X5PCAPW	T5X5PCAPMW	T5X5PCAPME	T5X5PCAPMB
5" x 5" Post Skirt	T5X5PSKIRTW	T5X5PSKIRTMW	T5X5PSKIRTME	T5X5PSKIRTMB
5.5" x 5.5" Pyramid Cap	A55X55PCAPW	A55X55PCAPMW	A55X55PCAPME	A55X55PCAPMB
5.5" x 5.5" Island Cap	A55X55ICAPW	A55X55ICAPMW	A55X55ICAPME	A55X55ICAPMB
5.5" x 5.5" Post Skirt	A55X55PSKIRTW	A55X55PSKIRTMW	A55X55PSKIRTME	A55X55PSKIRTMB
6" x 6" Island Cap	A6X6PCAPW	—	—	—
6" x 6" Post Skirt	A6X6PSKIRTW	—	—	—

• A 5.5" x 5.5" post sleeve is required for applications with 45° or other angled cuts.

• For 42" railing use 8' post sleeves.

## CLASSIC COMPOSITE SUPPORT RAILS

PRODUCT DESCRIPTION	TimberTech Model Number		
	White	MATTE ESPRESSO	Black
<b>CUSTOM SUPPORT RAILS - Laser-Etched for Aluminum Balusters</b>			
8' Custom Support Rails	AZTBULKSR8W	AZTBULKSR8ME	AZTBULKSR8B
<b>CUSTOM SUPPORT RAILS - Blank for 10' Bottom Support Rails</b>			
10' Custom Support Rails	AZTBULKUDSR10W	—	AZTBULKUDSR10B
<b>ALUMINUM SUPPORT RAILS - Drilled for Composite Balusters</b>			
8' Aluminum Support Rails	—	—	—
<b>ALUMINUM SUPPORT RAILS - Drilled at 5" on Center for Composite Balusters</b>			
10' Aluminum Support Rails	AZTBULKSR10W	—	—
<b>CUSTOM ALUMINUM SUPPORT RAILS - Marked at 4 1/2" on Center for Aluminum Balusters</b>			
10' Custom Aluminum Support Rails	AZTBULCUSTSR10W	—	AZTBULCUSTSR10B

# COMPOSITE RAILING

## 1. STYLES AND COLORS

### CLASSIC COMPOSITE SERIES



**PREMIER RAIL™**  
3.5" W x 2.7" H



**RADIANCERAIL®**  
2.9" W x 2.9" H



**TRADEMARK RAIL™**  
3.5" W x 2.7" H  
Only available in White and Matte White



**DRINK RAIL**  
Compatible with full-profile, Square-Shouldered boards

- TimberTech PVC Boards 5.5" W x 1" H
- TimberTech Composite Boards 5.36" W x .94" H

#### COLOR OPTIONS



GLOSS WHITE



MATTE WHITE



MATTE ESPRESSO



MATTE BLACK

Matte colors also include a 25-Year Fade & Stain Limited Warranty



## 2. INFILLS

1.25" x 1.25" Composite



.75" x .75" Aluminum Round and Square (Black only)



Glass Channel to fit 1/4" Tempered Glass



Glass panel sourced locally

CableRail

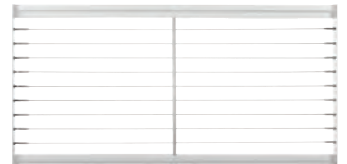

3. POST SLEEVES

Available in  
 4" x 4"  
 5" x 5"  
 5.5" x 5.5"  
 6" x 6" (White only)



CAPS AND SKIRTS

4" x 4" Cap  
 5.63" x 5.63" Profile



4" x 4" Island Cap  
 7.1" x 7.1" Profile



5" x 5" Cap  
 7.11" x 7.11" Profile



5.5" x 5.5" Island Cap  
 8.32" x 8.32" Profile



5.5" x 5.5" Pyramid Cap  
 8.32" x 8.32" Profile



6" x 6" Island Cap (White only)



4" x 4" Skirt  
 5.42" x 5.42" Profile



5" x 5" Skirt  
 6.36" x 6.36" Profile



5.5" x 5.5" Skirt  
 8.0" x 8.0" Profile



6" x 6" Skirt (White only)



LIGHTING

5.5" x 5.5" Lighted Island Cap  
 8.32" x 8.32" Profile



4" x 4", 5" x 5", 5.5" x 5.5"  
 Post Cap Light



Accent Lights  
 (Available in White, Matte White  
 or Architectural Bronze)



Under Rail Lights



# RADIANCE RAIL EXPRESS®

Simple, versatile milled-wood-inspired design



The Smart Set makes ordering and installation easier by bundling all the railing components together in a single kit.

PRODUCT DESCRIPTION	TimberTech Model Number		
	White	Black	KONA
<b>RADIANCE RAIL EXPRESS SMART SETS</b> - Includes Top & Bottom Rail, 4 x 4 Post Sleeve, 4" Post Cap, 4" Post Skirt, Hardware, Footblocks, Gaskets, 13 Balusters for 6', 18 Balusters for 8'			
6' RadianceRail Express Smart Set	TXSS6W	—	—
6' RadianceRail Express Stair Smart Set	TXSS6W	—	—
8' RadianceRail Express Smart Set	TXSS8W	—	—
8' RadianceRail Express Stair Smart Set	TXSS8W	—	—
<b>RADIANCE RAIL EXPRESS PACKS</b> Packs include Top & Bottom Rail, Hardware, Gaskets, and Footblocks			
6' RadianceRail Express Pack	TXRP6W	TXRP6B	TXRP6K
8' RadianceRail Express Pack	TXRP8W	TXRP8B	TXRP8K
<b>RADIANCE RAIL EXPRESS STAIR PACKS</b> Packs include Top & Bottom Rail, Hardware, and Footblocks			
8' RadianceRail Express Stair Pack	TXSRP8W	TXSRP8B	TXSRP8K
<b>RADIANCE RAIL EXPRESS ROUND ALUMINUM BALUSTER (RAB) RAIL PACKS</b> Packs include Top & Bottom Rail, Hardware, Gaskets, and Footblocks			
6' RadianceRail Express RAB Pack	TXRPRAB6W	TXRPRAB6B	TXRPRAB6K
8' RadianceRail Express RAB Pack	TXRPRAB8W	TXRPRAB8B	TXRPRAB8K
<b>RADIANCE RAIL EXPRESS ROUND ALUMINUM BALUSTER (RAB) STAIR PACKS</b> Packs include Top & Bottom Rail, Hardware, and Footblocks			
8' RadianceRail Express RAB Stair Pack	TXSRPRAB8W	TXSRPRAB8B	TXSRPRAB8K

Rail Packs are available in different lengths for level and stair applications with baluster options to accommodate a 36" or 42" railing height. RadianceRail Express pairs with the 4" x 4" x 39" Post Sleeve.

RadianceRail Express gaskets are included with the level Rail Packs, and RadianceRail Express hardware is included in all Rail Packs. Hardware and gaskets are also offered separately for installing two shorter sections while using one Rail Pack and for replacements.

## 1. STYLES AND COLORS

### COLOR OPTIONS

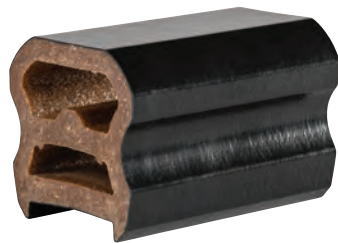
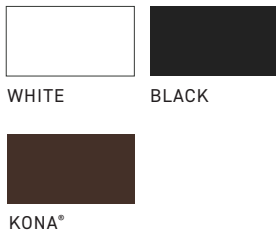

2.7" W x 2.4" H

## 2. INFILLS

1.25" x 1.25"  
Composite



.75" x .75"  
Metal Round



PRODUCT DESCRIPTION	TimberTech Model Number		
	White	Black	KONA
<b>RADIANCERAIL EXPRESS COMPOSITE BALUSTERS - 18/Pack</b>			
29.75" Square Composite Baluster	TX30BALW	TX30BALB	TX30BALK
35.75" Square Composite Baluster	TX36BALW	TX36BALB	TX36BALK
<b>RADIANCERAIL ROUND ALUMINUM BALUSTERS - 18/Pack</b>			
29" Round Aluminum Balusters	-	TX30RABALB	-
35" Round Aluminum Balusters	-	TX36RABALB	-
<b>RADIANCERAIL EXPRESS POST SLEEVES</b>			
4" x 4" x 39" Post Sleeve	AZT4X4PCV39W	AZT4X4PCV39B	AZT4X4PCV39K
4" x 4" x 96" Post Sleeve	AZT4X4PCV96W	AZT4X4PCV96B	AZT4X4PCV96K
<b>RADIANCERAIL EXPRESS POST CAPS AND SKIRTS</b>			
4" x 4" Post Cap	TX4X4PCAPW	TX4X4PCAPB	TX4X4PCAPK
4" x 4" Island Cap	TX4X4ICAPW	TX4X4ICAPB	TX4X4ICAPK
4" x 4" Post Skirt	AZT4X4PSKIRTW	AZT4X4PSKIRTB	AZT4X4PSKIRTK
<b>RADIANCERAIL EXPRESS HARDWARE KITS</b>			
Mounting Kit	TXBTKITW	TXBTKITB	TXBTKITK
Mounting Kit for Stairs	TXBKTSTAIRKITW	TXBKTSTAIRKITB	TXBKTSTAIRKITK
Gasket Pack Kit - Includes 4 gaskets (for level applications only)	TXGSTPKW	TXGSTPKB	TXGSTPKK

- Required number of composite balusters for level applications: 18 per 8' section, 13 per 6' section.
- Required number of composite balusters for stairs: 14 per 8' section, 11 per 6' section.
- Required number of round aluminum balusters for level applications: 20 per 8' section, 15 per 6' section.
- Required number of round aluminum balusters for stairs: 20 per 8' section, 15 per 6' section.
- Additional Post Sleeves, Post Caps, and Post Skirts may be purchased separately if needed.

### 3. POST SLEEVES

Available in  
4" x 4"



### CAPS AND SKIRTS

4" x 4" Cap  
5.63" x 5.63" Profile



4" x 4" Island Cap  
7.1" x 7.1" Profile



4" x 4" Skirt  
5.42" x 5.42" Profile



### LIGHTING

Accent Lights  
(Available in White, Matte  
White, and Architectural  
Bronze)



4" x 4" Post Cap Light



# TIMBERTECH® PVC RAILING

For clients who love the look of elegant, milled-wood railing but want to avoid the costly upkeep, choose our PVC railing. These railing designs feature classic aesthetics with superior performance and durability to ensure a long-lasting railing that requires minimal maintenance.



Statement Rail

## STATEMENT RAIL™

An elegant, milled-wood-inspired railing with a pre-routed design for easy installation. The wide, flat top rail lends clients functionality to set down their drinks, as well as an attractive, classic design. Plus, the innovative Racking Stair Section accommodates nearly any angle (18° to 40°) for stair applications.

### INFILL OPTIONS



HOLLOW SQUARE BALUSTERS



BLACK ALUMINUM BALUSTERS

### COLOR OPTION



WHITE



## PINNACLE RAIL™

A flat top rail with beauty and functionality, ideal for clients looking for a traditional aesthetic with modern functionality. The wide, flat top rail gives clients a useful surface to place drinks, plates, or décor, while the simple milled-wood-inspired detailing delivers an elegant aesthetic.

### INFILL & PANEL OPTIONS



SOLID SQUARE BALUSTERS

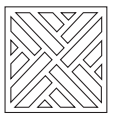

CHIPPENDALE TYPE 1 Panel (36")

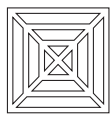

SQUARE WEB Panel (36")

### COLOR OPTION



WHITE

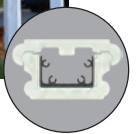

PRODUCT DESCRIPTION	TimberTech Model Number
	White
<b>STATEMENT SERIES Rail Kits - (2-3/4" Graspable Rail Kit with Reinforcements, 14 Hollow Balusters for 6', 18 Hollow Balusters for 8', Hardware and Footblocks)</b>	
6' 36" Statement PVC Level Rail Kit	ST60275-6K36H
8' 36" Statement PVC Level Rail Kit	ST60275-8K36H
6' 36" Statement PVC Stair Rail Kit	ST60275-6K36/SH
8' 36" Statement PVC Stair Rail Kit	ST60275-8K36/SH
6' 42" Statement PVC Level Rail Kit	ST60275-6K42H
8' 42" Statement PVC Level Rail Kit	ST60275-8K42H
<b>STATEMENT SERIES Rail Kits - Round Aluminum Baluster (RAB) - (2-3/4" Graspable Rail Kit with Reinforcements, 16 Hollow Round Balusters for 6' Level, 22 for 8' Level, (14) for 6' Stair, and (19) for 8' Stair, Hardware and Footblocks)</b>	
6' 36" Statement PVC Level Rail Kit - Round Aluminum Balusters	ST60275-6K36-AL
8' 36" Statement PVC Level Rail Kit - Round Aluminum Balusters	ST60275-8K36-AL
6' 36" Statement PVC Stair Rail Kit - Round Aluminum Balusters	ST60275-6K36/S-AL
8' 36" Statement PVC Stair Rail Kit - Round Aluminum Balusters	ST60275-8K36/S-AL
6' 42" Statement PVC Level Rail Kit - Round Aluminum Balusters	ST60275-6K42-AL
8' 42" Statement PVC Level Rail Kit - Round Aluminum Balusters	ST60275-8K42-AL
<b>PINNACLE SERIES Rail Kits - (3-1/2" Rail Kit with Reinforcements, 13 Solid Balusters for 6', 18 Solid Balusters for 8', Hardware and Footblocks)</b>	
6' 36" Pinnacle PVC Level Rail Kit	PN40350F-6K36
8' 36" Pinnacle PVC Level Rail Kit	PN40350F-8K36
6' 36" Pinnacle PVC Stair Rail Kit	PN40350F-6K36/S
8' 36" Pinnacle PVC Stair Rail Kit	PN40350F-8K36/S
6' 42" Pinnacle PVC Level Rail Kit	PN40350F-6K42
8' 42" Pinnacle PVC Level Rail Kit	PN40350F-8K42
<b>PINNACLE SERIES RAIL DECO PANELS</b>	
Pinnacle Decorative Panel, "Chippendale Type 1" for 36" High Rails. Panel Size 1-1/4" x 29-3/4" x 29-3/4"	PN40DP36-1
Pinnacle Decorative Panel, "Square Web" for 36" High Rails. Panel Size 1-1/4" x 29-3/4" x 29-3/4"	PN40DP36-3
Pinnacle Decorative Panel, "Chippendale Type 1" for 42" High Rails. Panel Size 1-1/4" x 35-3/4" x 35-3/4"	PN40DP42-1
Pinnacle Decorative Panel, "Square Web" for 42" High Rails. Panel Size 1-1/4" x 35-3/4" x 35-3/4"	PN40DP42-3
<b>PVC SERIES POST SLEEVES, POST CAPS, AND POST SKIRTS (For Use with Statement or Pinnacle Rail Kits)</b>	
5" Sq x 48" Post Sleeve 3/8" Wall, with adjustable Shims, for ST60 & PN40 Rail Systems	TTNEWEL5-EX
5" Sq x 108" Post Sleeve 3/8" Wall, with adjustable Shims, for ST60/PN40 Rail Systems	TTNEWEL5X108-EX
1" x 6-3/4" Plain Flat Post Cap to fit 5" Sq Post Sleeve, for ST60 & PN40 Rail Systems	TTNCFLAT5
Base Post Skirt Ring for 5" Extruded Post Sleeve for ST60 & PN40 Rail Systems	TTNBTR5-EX
<b>PVC SERIES HARDWARE</b>	
Statement Series Rail Bracket Kit, 4 Brackets & Screws, for Straight Level Rail Section	ST60BKTSSET
Statement Series Stair Rail Bracket Kit, 4 Brackets & Screws, for Stair Rail Section	ST60STAIRSET
Pinnacle Rail Bracket Kit, 4 Brackets & Screws, for Straight Level Rail Section	PN40BKTSSET
Pinnacle Stair Rail Bracket Kit, 2 Top Brackets, 2 Bottom Brackets & Screws, for Stair Rail Section	PN40STAIRSET
<b>PVC SERIES GATES (Actual Gate Size = 2" Less Than Gate Opening Width)</b>	
Statement ST60275 2-3/4" Top Reinforced Gate for 36 Wide Opening, 36" Rail Height (actual size 34" x 33-3/8"), Includes Hardware	ST60275G-3636
Statement ST60275 2-3/4" Top Reinforced Gate for 42 Wide Opening, 36" Rail Height (actual size 40" x 33-3/8"), Includes Hardware	ST60275G-4236
Pinnacle PN40-350 Flat Top Reinforced Gate for 36 Wide Opening, 36" Rail Height (actual size 34" x 33"), Includes Hardware	PN40350GF-3636
Pinnacle PN40-350 Flat Top Reinforced Gate for 42 Wide Opening, 36" Rail Height (actual size 40" x 33"), Includes Hardware	PN40350GF-4236

# TIMBERTECH® METAL RAILING

Introduce your clients to our metal railing portfolio to give them sleek designs that offer clear sightlines and stylish aesthetics. Made from powder-coated aluminum, our metal railings deliver safe, sturdy profiles that are easy on the eyes. Clients can choose from several options from traditional wrought-iron-inspired designs to modern, minimalist options.



Impression Rail Express® Horizontal Cable Rail  
Vintage Collection® in Coastline®



## IMPRESSION RAIL EXPRESS® SERIES

A panelized design, featuring pre-assembled balusters for easy installation. Available in three attractive top rail designs.

### TOP RAIL OPTIONS



CLASSIC



MODERN



DRINK RAIL

The Drink Rail system works with all full profile, Square-Shouldered deck boards, but NOT with scalloped boards (i.e., Terrain, Prime, Prime+, or ReliaBoard). Drink Rail cannot be used with glass infill. Only use 3" posts with the Drink Rail System, including in over-the-post applications.

### INFILL OPTIONS

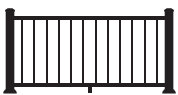

ALUMINUM



GLASS



VERTICAL CABLE

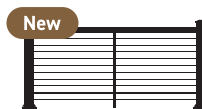

HORIZONTAL CABLE

### COLOR OPTIONS



WHITE



BLACK



DARK BRONZE

## IMPRESSION RAIL EXPRESS PANELS & TOP RAILS

PRODUCT DESCRIPTION	TimberTech Model Number		
	White	Black	DARK BRONZE
<b>IMPRESSION RAIL EXPRESS STANDARD UNIVERSAL PANEL - Baluster Panel, Bottom Rail, Bracket Hardware (TOP RAIL NOT INCLUDED)</b>			
36" 6' Level Universal Panel - 15 Baluster Panel	AZTIX36UNLP6W	AZTIX36UNLP6B	AZTIX36UNLP6BR
42" 6' Level Universal Panel- 15 Baluster Panel	AZTIX42UNLP6W	AZTIX42UNLP6B	AZTIX42UNLP6BR
36" 8' Level Universal Panel - 20 Baluster Panel	AZTIX36UNLP8W	AZTIX36UNLP8B	AZTIX36UNLP8BR
42" 8' Level Universal Panel - 20 Baluster Panel	AZTIX42UNLP8W	AZTIX42UNLP8B	AZTIX42UNLP8BR
<b>IMPRESSION RAIL EXPRESS STANDARD UNIVERSAL STAIR PANEL - Baluster Panel, Bottom Rail, Bracket Hardware (TOP RAIL NOT INCLUDED)</b>			
36" 6' Stair Universal Panel - 15 Baluster Panel	AZTIX36UNSP6W	AZTIX36UNSP6B	AZTIX36UNSP6BR
42" 6' Stair Universal Panel- 15 Baluster Panel	AZTIX42UNSP6W	AZTIX42UNSP6B	AZTIX42UNSP6BR
36" 8' Stair Universal Panel - 20 Baluster Panel	AZTIX36UNSP8W	AZTIX36UNSP8B	AZTIX36UNSP8BR
42" 8' Stair Universal Panel - 20 Baluster Panel	AZTIX42UNSP8W	AZTIX42UNSP8B	AZTIX42UNSP8BR
<b>IMPRESSION RAIL EXPRESS UNIVERSAL GLASS PANEL KIT - (1/4" Tempered Glass Sold Separately)</b>			
Universal Glass Panel Kit	AZTIXUGLASSP6W	AZTIXUGLASSP6B	AZTIXUGLASSP6BR
Universal Glass Slats Kit	AZTIXUGLASSL6W	AZTIXUGLASSL6B	AZTIXUGLASSL6BR
Glass Panel Extra Bracket Kit	AZTIXGBTKITW	AZTIXGBTKITB	AZTIXGBTKITBR
Glass Level 22 1/2" Bracket Kit	AZTIXGBKT22KITW	AZTIXGBKT22KITB	AZTIXGBKT22KITBR
<b>TOP RAILS (For Drink Rail Please Refer to "Drink Rail and Custom Top Rail Components" Below)</b>			
6' Classic Top Rail	AZTIXCSTR6W	AZTIXCSTR6B	AZTIXCSTR6BR
8' Classic Top Rail	AZTIXCSTR8W	AZTIXCSTR8B	AZTIXCSTR8BR
6' Modern Top Rail	AZTIXMDTR6W	AZTIXMDTR6B	AZTIXMDTR6BR
8' Modern Top Rail	AZTIXMDTR8W	AZTIXMDTR8B	AZTIXMDTR8BR
<b>DRINK RAIL AND CUSTOM TOP RAIL COMPONENTS</b>			
6' Universal Panel Cover for Drink Rail and Open Mid-Rail	AZTBULKIXBR6W	AZTBULKIXBR6B	AZTBULKIXBR6BR
8' Universal Panel Cover for Drink Rail and Open Mid-Rail	AZTBULKIXBR8W	AZTBULKIXBR8B	AZTBULKIXBR8BR
6' Unpunched Support Channel for open mid-rail*	AZTBULKIXCHN6W	AZTBULKIXCHN6B	AZTBULKIXCHN6BR
8' Unpunched Support Channel for open mid-rail*	AZTBULKIXCHN8W	AZTBULKIXCHN8B	AZTBULKIXCHN8BR
Drink Rail Kit - 12 Clips with Screws (4 clips/6' section & 6 clips/8' section)	AZTIXDRCKITW	AZTIXDRCKITB	AZTIXDRCKITBR
Drink Rail 3" Post Insert - 8 pack (works for all colors)	—	AZTIX3X3PLG	—

## POST KITS AND ACCESSORIES

Rail panels include balusters, bottom rail, and hardware to fasten the railing to the posts. 3" post kits include cap and skirt. 2" posts kits include bracket to run rail over the post and skirt.

2" posts are only intended for use with 18' Classic and Modern Top rails to run over the post on straight runs.

PRODUCT DESCRIPTION	TimberTech Model Number		
	White	Black	DARK BRONZE
<b>IMPRESSION RAIL EXPRESS STANDARD 3" POST KIT - Includes Post, Cap, and Skirt</b>			
38" x 3" x 3" Post Kit	AZTIX3X3PK38W	AZTIX3X3PK38B	AZTIX3X3PK38BR
43" x 3" x 3" Post Kit	AZTIX3X3PK43W	AZTIX3X3PK43B	AZTIX3X3PK43BR
48" x 3" x 3" Post Kit	AZTIX3X3PK48W	AZTIX3X3PK48B	AZTIX3X3PK48BR
<b>IMPRESSION RAIL EXPRESS ALUMINUM POST SKIRTS</b>			
2-Piece Aluminum Post Skirt for 3" Post	AZTIX3X3SKTALW	AZTIX3X3SKTALB	AZTIX3X3SKTALBR
<b>IMPRESSION RAIL EXPRESS® 3" FASCIA MOUNT POST KITS AND BRACKET KITS - Includes Post, Cap, and Base Insert</b>			
Fascia Mount 52" Post Kit (Post, Cap, and Base Insert)	AZTIX3X3FP52W	AZTIX3X3FP52B	AZTIX3X3FP52BR
Fascia Mount Bracket Kit Straight	AZTIX3X3FBSW	AZTIX3X3FBSB	AZTIX3X3FBSBR
Fascia Mount Bracket Outside Corner	AZTIX3X3FB0CW	AZTIX3X3FB0CB	AZTIX3X3FB0CBR
Fascia Mount Bracket Inside Corner	AZTIX3X3FBICW	AZTIX3X3FBICB	AZTIX3X3FBICBR
<b>IMPRESSION RAIL EXPRESS 4" POST COMPONENTS</b>			
4" x 39" Post Sleeve	AZTIX4x4PS39W	AZTIX4x4PS39B	AZTIX4x4PS39BR
4" x 48" Post Sleeve	AZTIX4x4PS48W	AZTIX4x4PS48B	AZTIX4x4PS48BR
4" x 108" Post Sleeve	AZTIX4x4PS108W	AZTIX4x4PS108B	AZTIX4x4PS108BR
4" Post Cap	AZTIX4x4PCW	AZTIX4x4PCB	AZTIX4x4PCBR
4" Post Skirt (2-Piece Polymer-Based Skirt)	AZTIX4x4PSKW	AZTIX4x4PSKB	AZTIX4x4PSKBR
<b>IMPRESSION RAIL EXPRESS OVER-THE-POST 2" POST KIT</b>			
36" x 2" x 2" Over-the-Post Bracket & Skirt	AZTIX2X2PK36W	AZTIX2X2PK36B	AZTIX2X2PK36BR
42" x 2" x 2" Over-the-Post Bracket & Skirt	AZTIX2X2PK42W	AZTIX2X2PK42B	AZTIX2X2PK42BR
18' Classic Top Rail	AZTBULKIXTR18W	AZTBULKIXTR18B	AZTBULKIXTR18BR
18' Modern Top Rail	AZTIXBMDTR18W	AZTIXBMDTR18B	AZTIXBMDTR18BR

## DECORATIVE COLLARS

PRODUCT DESCRIPTION	TimberTech Model Number		
	White	Black	DARK BRONZE
<b>DECORATIVE COLLARS</b>			
Decorative Collar Kit - Classic (2 Top Tail & 2 Bottom Rail Collars)	AZTIXLCVRKITW	AZTIXLCVRKITB	AZTIXLCVRKITBR
35° Stair Decorative Collar Kit - Classic (2 Top Tail & 2 Bottom Rail Collars)	AZTIXSCVRKITW	AZTIXSCVRKITB	AZTIXSCVRKITBR
Level Classic Top Rail Decorative Collar Bulk (30 Classic Top Rail Collars)	AZTIXLTCVR30W	AZTIXLTCVR30B	AZTIXLTCVR30BR
35° Stair Classic Top Rail Decorative Collar Bulk (30 Classic Top Rail Collars)	AZTIXSTCVR30W	AZTIXSTCVR30B	AZTIXSTCVR30BR
Level Decorative Collar Kit - Modern (2 Top Tail & 2 Bottom Rail Collars)	AZTIXLMDDCKITW	AZTIXLMDDCKITB	AZTIXLMDDCKITBR
35° Stair Decorative Collar Kit - Modern (2 Top Tail & 2 Bottom Rail Collars)	AZTIXSMDDCKITW	AZTIXSMDDCKITB	AZTIXSMDDCKITBR
Level Modern Top Rail Decorative Collar Bulk (30 Modern Top Rail Collars)	AZTIXLTMDDC30W	AZTIXLTMDDC30B	AZTIXLTMDDC30BR
35° Stair Modern Top Rail Decorative Collar Bulk (30 Modern Top Rail Collars)	AZTIXSTMDDC30W	AZTIXSTMDDC30B	AZTIXSTMDDC30BR
Level Bottom Rail Decorative Collar Bulk (30 bottom Rail collars)	AZTIXLBCVR30W	AZTIXLBCVR30B	AZTIXLBCVR30BR
35° Stair Bottom Rail Decorative Collar Bulk (30 bottom rail collars)	AZTIXSBCVR30W	AZTIXSBCVR30B	AZTIXSBCVR30BR

## INSTALLATION TOOLS AND BRACKETS

<b>IMPRESSION RAIL EXPRESS INSTALLATION TOOLS &amp; BRACKETS</b>			
Touch-Up Paint and Bracket Jig - <b>Order at least 1 per job</b>	AZTIXACCKITW	AZTIXACCKITB	AZTIXACCKITBR
Wall Mount Kit	AZTIXWBKTKITW	AZTIXWBKTKITB	AZTIXWBKTKITBR
Extra Bracket Kit Level and Stair	—	AZTIXBKTKIT	—
Level 22.5° Angle Bracket Kit	—	AZTIXBKT22KIT	—
Level 45° Angle Wall Bracket Kit	—	AZTIXWBKT45KIT	—



# IMPRESSION RAIL EXPRESS® CABLE RAIL

PRODUCT DESCRIPTION	TimberTech Model Number		
	White	Black	DARK BRONZE
<b>IMPRESSION RAIL EXPRESS UNIVERSAL VERTICAL CABLE PANEL KIT - Vertical Cable Railing Section with Stainless Steel Intermediate Balusters, Universal Panel Cover, Hardware, and Footblock (TOP RAIL NOT INCLUDED)</b>			
36" 6' Level Vertical Cable Railing Universal Panel	AZTIX36VCLP6W	AZTIX36VCLP6B	AZTIX36VCLP6BR
36" 8' Level Vertical Cable Railing Universal Panel	AZTIX36VCLP8W	AZTIX36VCLP8B	AZTIX36VCLP8BR
42" 6' Level Vertical Cable Railing Universal Panel <i>(Residential Only)</i>	AZTIX42VCLP6W	AZTIX42VCLP6B	AZTIX42VCLP6BR
42" 8' Level Vertical Cable Railing Universal Panel <i>(Residential Only)</i>	AZTIX42VCLP8W	AZTIX42VCLP8B	AZTIX42VCLP8BR
<b>IMPRESSION RAIL EXPRESS UNIVERSAL VERTICAL CABLE STAIR PANEL KIT - Vertical Cable Railing Section, Universal Panel Cover, Hardware, and Footblock (TOP RAIL NOT INCLUDED)</b>			
36" 6' Stair Vertical Cable Railing Universal Panel	AZTIX36VCSPP6W	AZTIX36VCSPP6B	AZTIX36VCSPP6BR
42" 6' Stair Vertical Cable Railing Universal Panel <i>(Residential Only)</i>	AZTIX42VCSPP6W	AZTIX42VCSPP6B	AZTIX42VCSPP6BR
<b>IMPRESSION RAIL® EXPRESS HORIZONTAL CABLE LEVEL RAIL KITS - Center Baluster, Top Support Channel, and Bracket Hardware (TOP RAIL NOT INCLUDED)</b>			
36"/42" 6' Level Horizontal Cable Railing Section Kit	AZTIXHCLP6W	AZTIXHCLP6B	AZTIXHCLP6BR
36"/42" 8' Level Horizontal Cable Railing Section Kit	AZTIXHCLP8W	AZTIXHCLP8B	AZTIXHCLP8BR
<b>IMPRESSION RAIL® EXPRESS HORIZONTAL CABLE STAIR RAIL KITS - Center Baluster, Top Support Channel, and Bracket Hardware (TOP RAIL NOT INCLUDED)</b>			
36"/42" 6' Stair Horizontal Cable Railing Section Kit	AZTIXHCSP6W	AZTIXHCSP6B	AZTIXHCSP6BR
<b>IMPRESSION RAIL® EXPRESS HORIZONTAL CABLE RAIL POSTS FOR 36" RAIL SYSTEMS - Includes Post, Base Plate, Cap, and Skirt</b>			
3" x 3" Horizontal Cable Post Kit, 90 Degree Corner with Insert	AZTIXHC90PK38W	AZTIXHC90PK38B	AZTIXHC90PK38BR
3" x 3" Horizontal Cable Post Kit, Level End	AZTIXHCEPK38W	AZTIXHCEPK38B	AZTIXHCEPK38BR
3" x 3" Horizontal Cable Post Kit, Level Inline	AZTIXHCIPK38W	AZTIXHCIPK38B	AZTIXHCIPK38BR
3" x 3" Horizontal Cable Post Kit, Stair Bottom End	—	AZTIXHCESPK43B	AZTIXHCESPK43BR
3" x 3" Impression Rail Express Horizontal Cable Post Kit, Stair Bottom End	AZTIXHCESPK43W	—	—
3" x 3" Horizontal Cable Post Kit, Stair Inline	AZTIXHCISPK43W	AZTIXHCISPK43B	AZTIXHCISPK43BR
<b>IMPRESSION RAIL® EXPRESS HORIZONTAL CABLE RAIL POSTS FOR 42" RAIL SYSTEMS - Includes Post, Base Plate, Cap, and Skirt</b>			
3" x 3" Horizontal Cable Post Kit, 90 Degree Corner with Insert	AZTIXHC90PK43W	AZTIXHC90PK43B	AZTIXHC90PK43BR
3" x 3" Horizontal Cable Post Kit, Level End	AZTIXHCEPK43W	AZTIXHCEPK43B	AZTIXHCEPK43BR
3" x 3" Horizontal Cable Post Kit, Level Inline	AZTIXHCIPK43W	AZTIXHCIPK43B	AZTIXHCIPK43BR
3" x 3" Horizontal Cable Post Kit, Stair Bottom End	AZTIXHCESPK48W	AZTIXHCESPK48B	AZTIXHCESPK48BR
3" x 3" Horizontal Cable Post Kit, Stair Inline	AZTIXHCISPK48W	AZTIXHCISPK48B	AZTIXHCISPK48BR

PRODUCT DESCRIPTION	Length (ft.)			
	10'	20'	40'	60'
316SS Cable & Hardware	AZTIXHC10CABLE	AZTIXHC20CABLE	AZTIXHC40CABLE	AZTIXHC60CABLE

PRODUCT DESCRIPTION	TimberTech Model Number		
	White	Black	DARK BRONZE
<b>IMPRESSION RAIL® EXPRESS HORIZONTAL CABLE RAIL REPLACEMENT PARTS</b>			
36"/42" Horizontal Cable Center Baluster Replacement - Level Section	AZTIXHCLBRW	AZTIXHCLBRB	AZTIXHCLBRBR
36"/42" Horizontal Cable Center Baluster Replacement - Stair Section	AZTIXHCSBRW	AZTIXHCSBRB	AZTIXHCSBRBR
Horizontal Cable Stair Section Post Hole Plug	AZTIXHCSPHPW	AZTIXHCSPHPB	AZTIXHCSPHPBR
Horizontal Cable Level Section Post Hole Plug	AZTIXHCLPHPW	AZTIXHCLPHPB	AZTIXHCLPHPBR

PRODUCT DESCRIPTION	TimberTech Model Number
	<b>IMPRESSION RAIL® EXPRESS HORIZONTAL CABLE RAIL TOOLS</b>
Horizontal Cable Acc Kit (Quick-Connect Release, 90 Degree & Straight Threading Tools)	AZTIXHCACCKIT
Cable Gripper Attachment	AZTIXCRGRIP
Horizontal Cable Level Section Picket Plug	AZTIXHCDPP
Horizontal Cable Stair Section Picket Plug	AZTIXHCSPP
Horizontal Cable Stair Section Angle Washer	AZTIXHCSAW
3" x 36" Horizontal Cable 90 Degree Corner Post Insert	AZTIXHC90PI36
3" x 36" Horizontal Cable 90 Degree Corner Post Insert	AZTIXHC90PI42
.250 Hole X .749L Christmas Tree Clip - .728 OD HEAD	AZTIXHCCT
1/8" T-316 Threaded Stud Receiver, 1/4" UNC thread (Body Length: 3-1/32")	AZTIXHCTSR
1/8" T-316 Cable Receiver (Body Length: 3-1/32")	AZTIXHCFCR
T-316 Bright Polished Fast Fitting Dome Cap	AZTIXHCFCDC
Horizontal Cable M6 Allen Wrench	AZTIXHCAW

# METAL RAILING

## 1. STYLES AND COLORS

### IMPRESSION RAIL EXPRESS® SERIES

#### COLOR OPTIONS



WHITE



BLACK



DARK BRONZE



**CLASSIC**  
2.5" x 2.3"



**MODERN**  
2.25" X 1.8"



**DRINK RAIL**  
2.7" X 5.5"

The Drink Rail system works with all full-profile, Square-Shouldered deck boards, but NOT with scalloped boards (i.e., Terrain, Terrain+, Prime, Prime+, or ReliaBoard). Drink Rail cannot be used with glass or open mid rail infill. Only use 3" posts with the Drink Rail System, including in over-the-post applications.

## 2. INFILLS

Aluminum Balusters  
Rectangular only

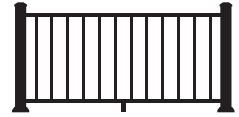

Aluminum Balusters  
With open mid-rail

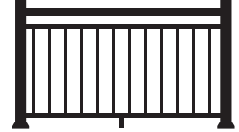

Glass Channel Kit



Glass not included

Glass Channel Kit  
With open mid-rail



Glass not included

Vertical Cable Rail

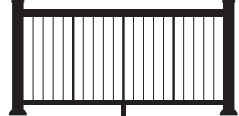

**New**

Horizontal Cable Rail

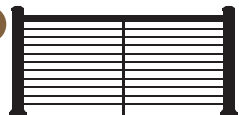

Impression Rail Express® in Dark Bronze

3. POST SLEEVES

**For 3" Post Applications**  
3" x 3" Post



CAPS AND SKIRTS

3" x 3" Cap  
3.39" x 3.39" Profile



3" x 3" Skirt  
5.38 x 5.38" Profile



**For Over-the-Post Applications  
with 18' Classic or Modern Top Rail**

2" x 2" Post



2" x 2" Skirt  
3.88" x 3.88" Profile



**For 4" Post Applications**  
4" x 4" Post Sleeve



4" x 4" Cap  
4.4" x 4.4" Profile



4" x 4" Skirt  
5.38" x 5.38" Profile



LIGHTING

Small Accent Light

New



For SKUs and color options see page 40.

3" Post Cap Light

New



3" x 3"  
Indirect Light Post Cap



3" x 3"  
Perimeter Light Post Cap



## COMPOSITE ADA HANDRAIL

- ADA-compliant handrail system with aluminum reinforcement to reduce bowing and provide enduring strength
- Adjustable joiners to accommodate any transition
- Installs easily with no special tools required

### COLOR OPTIONS



WHITE



BLACK

PRODUCT DESCRIPTION	TimberTech Model Number	
	White	Black
<b>COMPOSITE ADA HANDRAIL</b>		
ADA 104" Grab Rail	AZTADA104RSAW	AZTADA104RSAB
ADA 90° Corner with Joiners	AZTADA90DCWJW	AZTADA90DCWJB
ADA 90° Inside Corner Bracket	AZTADA90DICBW	AZTADA90DICBB
ADA Grab Rail End Cap - 4/Pkg	AZTADARECW	AZTADARECB
ADA Hand Rail Bracket Kit	AZTADAHRBKW	AZTADAHRBKB
ADA Handicap Loop	AZTADAHLW	AZTADAHLB
ADA Joint Ring - 4/Pkg	AZTADAJRW	AZTADAJRB
ADA Post Return	AZTADAPRW	AZTADAPRB
ADA Rail End Cap - 4/Pkg	AZTADARECW	AZTADARECB
ADA Straight Wall Return Kit	AZTADASWRKW	AZTADASWRKB
ADA Wall Return Cover Plate - 4/Pkg	AZTADAWRCPW	AZTADAWRCPB
ADA Wall Return with Joiner, Cover, and Plate	AZTADAWRCPWJW	AZTADAWRCPWJB
ADA External Adjustable Joiner	AZTADAEAJW	AZTADAEAJB
	TimberTech Model Number	
ADA Straight Joiner - 4/Pkg	AZTADASJ	
ADA Adjustable Joiner - 4/Pkg	AZTADAAJ	

## METAL ADA HANDRAIL

- ADA-compliant handrail system, made of powder-coated aluminum, that passes codes for guardrail loads
- Adjustable joiners to accommodate any transition
- Installs easily with no special tools required

### COLOR OPTIONS



WHITE



BLACK



DARK BRONZE

PRODUCT DESCRIPTION	TimberTech Model Number		
	White	Black	DARK BRONZE
<b>ADA HANDRAIL FOR IMPRESSION RAIL EXPRESS®</b> - Kits include all the components for the most common ADA handrail applications. Combine kits for a custom application.			
<b>Aluminum ADA Pipe Rail and 90° Return Kit Black</b> (2 Wall Return Brackets, 1.5" x 94" Aluminum Railing; 2 Backer Plates, Hardware, Rings, and Covers)	AZTIXADAPR90DRKW	AZTIXADAPR90DRKB	AZTIXADAPR90DRKBR
<b>Aluminum ADA Pipe Rail Extension Kit</b> (2 Support Brackets, 1.5" x 94" Aluminum Railing; 2 Backer Plates, Hardware, Connectors, and Covers)	AZTIXADAPREKW	AZTIXADAPREKB	AZTIXADAPREKBR
<b>Aluminum ADA Handicap Loop Kit</b> (2 "D" Loops; 1 support Bracket; 2 Adjustable Joiners, 2 Backer Plates, Hardware, Connectors, and Covers)	AZTIXADAHLKW	AZTIXADAHLKB	AZTIXADAHLKBR
<b>Aluminum ADA 90° Wall Return Kit</b> (2 Wall Return Brackets, Hardware, Rings, Covers, and Backer Plates)	AZTIXADA90DRKW	AZTIXADA90DRKB	AZTIXADA90DRKBR
Aluminum ADA Support Bracket - 1 Support Bracket & Hardware	AZTIXADAMSBW	AZTIXADAMSBB	AZTIXADAMSBBR
Aluminum ADA Adjustable Elbow	AZTIXADAADJW	AZTIXADAADJB	AZTIXADAADJBR
Aluminum ADA 90 Degree Wall Return, Hardware and Ring Cover	AZTIXADA90WRW	AZTIXADA90WRB	AZTIXADA90WRBR
Aluminum ADA Handrail Pipes 1.5" x 94"	AZTIXADA94RW	AZTIXADA94RB	AZTIXADA94RBR



## SECURE MOUNT POST

- Allows for railing installations without a wood post
- Can be installed on wood, concrete, and composite surfaces
- Adjustable for 36" or 42" rail applications

PRODUCT DESCRIPTION	TimberTech Model Number
<b>SECURE MOUNT POST</b>	
4" Secure Mount Post	AZTSMP3642
6" Secure Mount Post Adapter	AZTSMP6ADAPTOR
Deck Mounting Kit	AZTSMPDMK



## UNIVERSAL GATE KIT

- For use with the Classic Composite Series
- Does not include top rail, bottom rail, or balusters
- Maximum width opening: 48"

PRODUCT DESCRIPTION	TimberTech Model Number		
	White	MATTE WHITE	MATTE BLACK
<b>UNIVERSAL GATE KIT - For Use with Classic Composite Series</b> Includes Hinge and Latch and Side Supports to Convert Classic Composite Rail Pack or Kit to a Gate (Railing and Balusters Sold Separately)			
36" Universal Gate Kit	AZTGATEW	AZTGATEMW	AZTGATEMB

### COLOR OPTIONS



WHITE      MATTE WHITE      MATTE BLACK

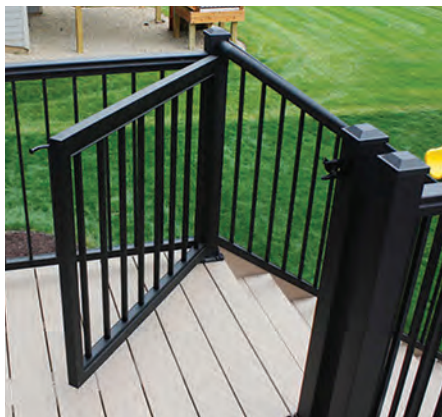

## IMPRESSION RAIL EXPRESS® GATE KIT

- For 38" or 42" railing heights
- Available in White, Black, or Dark Bronze
- Maximum width opening: 49"

PRODUCT DESCRIPTION	TimberTech Model Number		
	White	Black	DARK BRONZE
<b>IMPRESSION RAIL EXPRESS GATE KIT - Kit Includes Panel, Top &amp; Bottom Channel Covers, Latch and Hinge Kit (For up to 50" Openings)</b>			
36" IRX Gate Kit	AZTIXGATE36W	AZTIXGATE36B	AZTIXGATE36BR
42" IRX Gate Kit	AZTIXGATE42W	AZTIXGATE42B	AZTIXGATE42BR

### COLOR OPTIONS



WHITE      BLACK      DARK BRONZE

# TIMBERTECH® LIGHTING

Give your clients greater functionality in their deck build with in-deck and railing light from TimberTech. These durable, stylish designs can be incorporated into nearly any part of the deck layout for curated lighting.



Vintage® Collection in English Walnut and Reserve Collection in Antique Leather, Classic Composite Series with Drink Rail + Lighted Island Cap

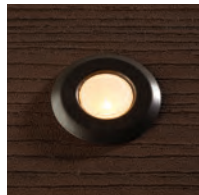

IN-DECK LIGHT



RISER LIGHT

## DECK LIGHTING

PRODUCT DESCRIPTION	TimberTech Model Number
<b>DECK LIGHTING</b>	
LED In-Deck Light - Architectural Bronze - 4/Pkg	AZTDLLEDINDECKG2
LED Riser Light - Architectural Bronze	AZTDLLEDRISERB
LED Riser Light - White	AZTDLLEDRISERW
100w Transformer for LED Lighting (12 volt)	AZTDL100TRAN
16/2 100' wire for LED Lighting	AZTDLLEDWIRE
150W PowerPack/Dimmer	AZTDL150PP

## COMPOSITE RAIL LIGHTING

PRODUCT DESCRIPTION	TimberTech Model Number
<b>COMPOSITE RAIL LIGHTING</b>	
4" x 4" LED Post Cap Light	TDL4X4CAPMOD
5" x 5" LED Post Cap Light	TDL5X5CAPMOD
5½" x 5½" LED Post Cap Light	ADL55X55CAPMOD
5½" x 5½" LED Lighted Island Cap - White	ADL55X55ICAPMODW
5½" x 5½" LED Lighted Island Cap - Matte White	ADL55X55ICAPMODMW
5½" x 5½" LED Lighted Island Cap - Matte Black	ADL55X55ICAPMODMB
5½" x 5½" LED Lighted Island Cap - Matte Espresso	ADL55X55ICAPMODME
LED Accent Light - Architectural Bronze	AZTDLLEDACCB
LED Accent Light - White	AZTDLLEDACCW
LED Accent Light - Matte White	AZTDLLEDACMW
LED Under Rail Light - 4/Pkg	AZTDLLEDURAIL



POST CAP LIGHT



LIGHTED ISLAND CAP



ACCENT LIGHT



UNDER RAIL LIGHT

## IMPRESSION RAIL EXPRESS® LIGHTING

PRODUCT DESCRIPTION	TimberTech Model Number
<b>IMPRESSION RAIL EXPRESS® LIGHTING</b>	
3" x 3" Perimeter Light Post Cap - Black	AZTIXLIGPCB
3" x 3" Perimeter Light Post Cap - White	AZTIXLIGPCW
3" x 3" Perimeter Light Post Cap - Dark Bronze	AZTIXLIGPCBR
3" x 3" Indirect/Concealed Down Light Post Cap - Black	AZTIXLIGDCB
3" x 3" Indirect/Concealed Down Light Post Cap - White	AZTIXLIGDCW
3" x 3" Indirect/Concealed Down Light Post Cap - Dark Bronze	AZTIXLIGDCBR
3" Post Cap Light	AZTDL3X3LEDCAP
Small Accent Light - Black	AZTIXLEDACCB
Small Accent Light - Dark Bronze	AZTIXLEDACCBR
Small Accent Light - White	AZTIXLEDACCW

New



3" POST CAP LIGHT

New



SMALL ACCENT LIGHT





**COLOR OPTIONS**



**DRYSPACE®**

Our extruded vinyl underdeck water management system, DrySpace, collects and redirects water to keep the area beneath cleaner and drier. Ideal for second-story decks, DrySpace can be attached to new or existing joists, helping to double your clients' outdoor living spaces.

Available In:

- 12" on-center spans in 12' lengths
- 16" on-center spans in 12' and 16' lengths
- Available in 12' and 16' when purchased as individual components

PRODUCT DESCRIPTION	TimberTech Model Number			
	12' BONE	16' BONE	12' White	16' White
<b>DRYSPACE</b>				
Combo Brackets	DSCOMB012B	DSCOMB016B	DSCOMB012W	DSCOMB016W
Double Combo Brackets	—	DSDBLCOMB016B	—	DSDBLCOMB016W
12" Panel Only	DS12PANEL12B	DS12PANEL16B	DS12PANEL12W	DS12PANEL16W
16" Panel Only	DS16PANEL12B	DS16PANEL16B	DS16PANEL12W	DS16PANEL16W
Ledger Bracket	DSFBRACKET12B	—	DSFBRACKET12W	—
12" O.C. DrySpace Kit*	DS12KIT12B	—	DS12KIT12W	—
16" O.C. DrySpace Kit*	DS16KIT12B	DS16KIT16B	DS16KIT12W	DS16KIT16W

\* One kit covers 6 joist bays

**PRO-TAC™ FLASHING AND JOIST TAPE**



- Heavy-duty, flexible, all-weather tape that resists moisture to extend the life of decking substructures
- Butyl adhesive provides an advanced, secure bond, making it difficult to peel off or end with secure bond to joist.
- Can be installed in all weather conditions; rated for use in temperatures from -70°F to 200°F

PRODUCT DESCRIPTION	TimberTech Model Number	
	25'	65'
<b>PRO-TAC TAPE</b>		
1.625" Pro-Tac Joist Tape	—	PTCS1625X65B
2.5" Pro-Tac Joist Tape	—	PTCS25X65B
3.25" Pro-Tac Joist Tape	—	PTCS325X65B
4" Pro-Tac Joist Tape	—	PTCS4X65B
12" Pro-Tac Joist Tape	PTCS12X25B	—

**TIMBERTECH DECKCLEANER™\***



Non-toxic, bleach-free, and biodegradable

- Cleans decking, railing, trim, and moulding
- Concentrated formula that removes dirt, mold, mildew, dust, pollen, and more
- Cleans approximately 1,000 square feet of surface area when properly diluted
- Guaranteed not to damage TimberTech products, or affect the warranty, when used as directed on the recommended products
- Not intended for wood or traditional composite decking (non-capped)

PRODUCT DESCRIPTION	TimberTech Model Number
<b>TIMBERTECH DECKCLEANER</b>	
1 Gallon DeckCleaner (Case of 4)	TTCLNCASE1G

\*See specific product care and cleaning instructions for further details and proper applications

PRODUCT	BRUSH TYPE & RECOMMENDATION
Advanced PVC Decking and Porch	A stiff natural fiber brush
Composite Decking, Specialty Decking	Medium to stiff, nylon brush   Quickie Bulldozer Poly Fiber Deck Brush

**AZEK**  
EXTERIORS

The pros' #1 choice

For exteriors that endure for decades and delight homeowners today, contractors choose AZEK PVC.

## #1 in Performance Trim

AZEK® Trim is the perfect replacement for wood trim and also performs beautifully as fascia, soffit, beadboard, cornerboards, window and door surrounds, column wraps, decorative mouldings, millwork, and much more.



TRIM - SMOOTH



TRIM - WOODGRAIN



RABBETED TRIM



UNIVERSAL SKIRT BOARD



INTEGRATED DRIP EDGE

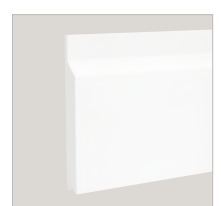

ONE-PIECE SKIRT BOARD



CORNERBOARDS - SMOOTH



CORNERBOARDS - WOODGRAIN

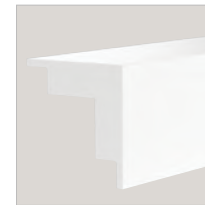

RABBETED CORNERBOARDS

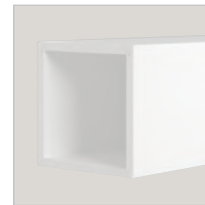

COLUMN WRAP

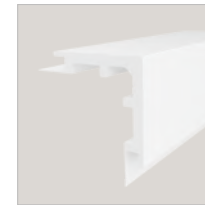

QUICK CORNER®



BEADBOARD



AZEK SHEETS



AZEK-TO-MILL (ATM)



AZEK FLANGE SLOTTED WINDOW TRIM



J-CASING



BRICK MOULD J-CASING



TONGUE-AND-GROOVE

# AZEK® Trim with Protective Film

AZEK Trim is cellular PVC with a crisp White semi-matte finish providing years of low maintenance for homeowners. Classic AZEK Trim in smooth and woodgrain finish is now covered with a protective film, ensuring it looks as beautiful on your home as it does when it leaves our factory.

AZEK Trim with protective film should be kept dry prior to installation. Do not expose film to direct sunlight for extended periods. Protective film can be removed prior to, during or immediately after installation.

## AZEK TRIM FILM IS ON THESE SMOOTH AND WOODGRAIN TRIM PRODUCTS

Nominal Thickness	Nominal Width						
	4	5	6	8	10	12	16
5/8	•	•	•	•	•	•	•
4/4	•	•	•	•	•	•	•
5/4	•	•	•	•	•	•	•



	12'	18'	20'
<b>5/8" TRIMBOARD, 5/8" THICKNESS</b>			
5/8" x 3-1/2" Trimboard Smooth	AT06204144	AT06204216	—
5/8" x 3-1/2" Trimboard Woodgrain	AF06204144	AF06204216	—
5/8" x 5-1/2" Trimboard Smooth	AT06206144	AT06206216	—
5/8" x 5-1/2" Trimboard Woodgrain	AF06206144	AF06206216	—
5/8" x 7-1/4" Trimboard Smooth	AT06208144	AT06208216	—
5/8" x 7-1/4" Trimboard Woodgrain	AF06208144	AF06208216	—
5/8" x 9-1/4" Trimboard Smooth	AT06210144	AT06210216	—
5/8" x 9-1/4" Trimboard Woodgrain	AF06210144	AF06210216	—
5/8" x 11-1/4" Trimboard Smooth	AT06212144	AT06212216	—
5/8" x 11-1/4" Trimboard Woodgrain	AF06212144	AF06212216	—
5/8" x 15-1/4" Trimboard Smooth	AT06216144	AT06216216	—
5/8" x 15-1/4" Trimboard Woodgrain	AF06216144	AF06216216	—

		12'	18'	20'
<b>4/4 TRIMBOARD, 3/4" THICKNESS</b>				
Nominal	Actual			
4/4 x 2	3/4" x 1-1/2" Trimboard Smooth	—	AT10002216	—
4/4 x 2	3/4" x 1-1/2" Trimboard Woodgrain	—	AF10002216	—
4/4 x 3	3/4" x 2 1/2" Trimboard Smooth	—	AT10003216	—
4/4 x 4	3/4" x 3-1/2" Trimboard Smooth	AT10004144	AT10004216	—
4/4 x 4	3/4" x 3-1/2" Trimboard Woodgrain	AF10004144	AF10004216	—
4/4 x 5	3/4" x 4-1/2" Trimboard Smooth	AT10005144	AT10005216	—
4/4 x 5	3/4" x 4-1/2" Trimboard Woodgrain	AF10005144	AF10005216	—
4/4 x 6	3/4" x 5-1/2" Trimboard Smooth	AT10006144	AT10006216	—
4/4 x 6	3/4" x 5-1/2" Trimboard Woodgrain	AF10006144	AF10006216	—
4/4 x 8	3/4" x 7-1/4" Trimboard Smooth	AT10008144	AT10008216	—
4/4 x 8	3/4" x 7-1/4" Trimboard Woodgrain	AF10008144	AF10008216	—
4/4 x 10	3/4" x 9-1/4" Trimboard Smooth	AT10010144	AT10010216	—
4/4 x 10	3/4" x 9-1/4" Trimboard Woodgrain	AF10010144	AF10010216	—
4/4 x 12	3/4" x 11-1/4" Trimboard Smooth	AT10012144	AT10012216	—
4/4 x 12	3/4" x 11-1/4" Trimboard Woodgrain	AF10012144	AF10012216	—
4/4 x 16	3/4" x 15-1/4" Trimboard Smooth	AT10016144	AT10016216	—
4/4 x 16	3/4" x 15-1/4" Trimboard Woodgrain	AF10016144	AF10016216	—

## Classic AZEK Trim, Versatile and Easy

AZEK Trim is a finishing touch that is far superior to wood. AZEK Trim is more durable and keeps its appearance longer with little maintenance. It is easily milled, routed, and heat formed for exquisite custom looks or curved applications. No staining or sealing needed. AZEK Trim is easily painted if desired, following AZEK painting guidelines.



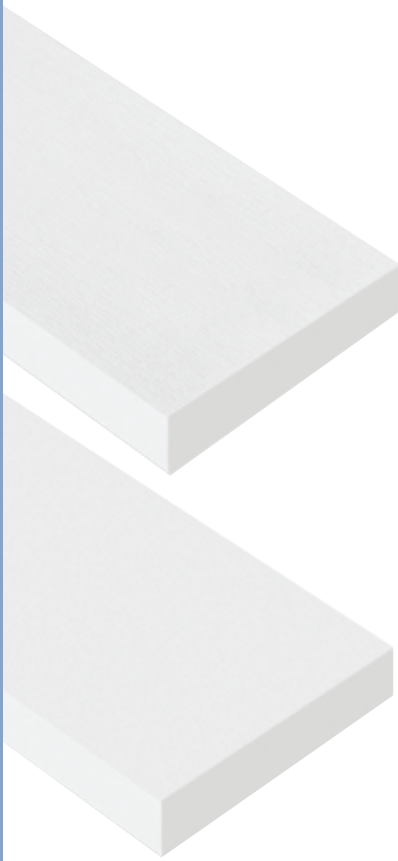

## AZEK® Trim with PaintPro® Technology

The best substrate for paint, AZEK Trim with PaintPro® technology has all the benefits of AZEK Classic Trim including being virtually impervious to moisture. It adds the benefit of a superior paint bond that enhances long-term performance. No primer needed. Paint goes on smoother, dries faster, and adheres stronger than with ordinary PVC.

## Classic AZEK Sheet

Applications over 16" wide are easy with Classic AZEK Sheet. Ideal for use in bay windows, dormers and raised panels.

## PaintPro Sheet

Applications over 16" wide are easy with AZEK PaintPro Sheet. Ideal for use in bay windows, dormers, and raised panels.

		12'	18'	20'
<b>5/4 TRIMBOARD, 1" THICKNESS</b>				
Nominal	Actual			
5/4 x 4	1" x 3-1/2" Trimboard Smooth	AT12504144	AT12504216	AT12504240
5/4 x 4	1" x 3-1/2" Trimboard Woodgrain	AF12504144	AF12504216	AFT12504240
5/4 x 5	1" x 4-1/2" Trimboard Smooth	AT12505144	AT12505216	AT12505240
5/4 x 5	1" x 4-1/2" Trimboard Woodgrain	AF12505144	AF12505216	AF12505240
5/4 x 6	1" x 5-1/2" Trimboard Smooth	AT12506144	AT12506216	AT12506240
5/4 x 6	1" x 5-1/2" Trimboard Woodgrain	AF12506144	AF12506216	AF12506240
5/4 x 8	1" x 7-1/4" Trimboard Smooth	AT12508144	AT12508216	AT12508240
5/4 x 8	1" x 7-1/4" Trimboard Woodgrain	AF12508144	AF12508216	AF12508240
5/4 x 10	1" x 9-1/4" Trimboard Smooth	AT12510144	AT12510216	AT12510240
5/4 x 10	1" x 9-1/4" Trimboard Woodgrain	AF12510144	AF12510216	AF12510240
5/4 x 12	1" x 11-1/4" Trimboard Smooth	AT12512144	AT12512216	AT12512240
5/4 x 12	1" x 11-1/4" Trimboard Woodgrain	AF12512144	AF12512216	AF12512240
5/4 x 16	1" x 15-1/4" Trimboard Smooth	AT12516144	AT12516216	AT12516240
5/4 x 16	1" x 15-1/4" Trimboard Woodgrain	AF12516144	AF12516216	AF12516240

		12'	18'	20'
<b>6/4 TRIMBOARD, 1-1/4" THICKNESS</b>				
Nominal	Actual			
6/4 x 4	1-1/4" x 3-1/2" Trimboard Woodgrain	—	—	AF15004240
6/4 x 6	1-1/4" x 5-1/2" Trimboard Woodgrain	—	—	AF15006240
6/4 x 8	1-1/4" x 7-1/4" Trimboard Woodgrain	—	—	AF15008240
6/4 x 10	1-1/4" x 9-1/4" Trimboard Woodgrain	—	—	AF15010240
6/4 x 12	1-1/4" x 11-1/4" Trimboard Woodgrain	—	—	AF15012240

		12'	16'	20'
<b>PAINTPRO® TRIM Two-Sided, Reversible Finish: Smooth and Woodgrain</b>				
Nominal	Actual			
4/4 x 2	3/4" x 1-1/2"	—	AF10002192PP	—
4/4 x 3	3/4" x 2-1/2"	—	AF10003192PP	—
4/4 x 4	3/4" x 3-1/2"	—	AF10004192PP	—
4/4 x 6	3/4" x 5-1/2"	—	AF10006192PP	—
4/4 x 8	3/4" x 7-1/4"	—	AF10008192PP	—
4/4 x 10	3/4" x 9-1/4"	—	AF10010192PP	—
4/4 x 12	3/4" x 11-1/4"	—	AF10012192PP	—
4/4 x 16	3/4" x 15-1/4"	—	AF10016192PP	—
5/4 x 4	1" x 3-1/2"	—	AF12504192PP	—
5/4 x 6	1" x 5-1/2"	—	AF12506192PP	—
5/4 x 8	1" x 7-1/4"	—	AF12508192PP	—
5/4 x 10	1" x 9-1/4"	—	AF12510192PP	—
5/4 x 12	1" x 11-1/4"	—	AF12512192PP	—
5/4 x 16	1" x 15-1/4"	—	AF12516192PP	—

		8'	10'	12'	18'	20'
<b>CLASSIC AZEK SHEET</b>						
Actual						
3/8" x 48" Sheet Smooth	AS03848096	AS03848120	AS03848144	AS03848216	—	—
3/8" x 48" Sheet Woodgrain	ASF03848096	ASF03848120	—	—	—	—
1/2" x 48" Sheet Smooth	AS01248096	AS01248120	AS01248144	AS01248216	—	—
1/2" x 48" Sheet Woodgrain	ASF01248096	ASF01248120	—	—	—	—
5/8" x 48" Sheet Smooth	AS05848096	AS05848120	AS05848144	AS05848216	—	—
3/4" x 48" Sheet Smooth	AS03448096	AS03448120	AS03448144	AS03448216	—	—
3/4" x 48" Sheet Woodgrain	ASF03448096	ASF03448120	—	—	—	—
1" x 48" Sheet Smooth	AS10048096	AS10048120	AS10048144	AS10048216	AS10048240	—

		8'	10'	12'	20'
<b>PAINTPRO® SHEET Two-Sided, Reversible Finish: Smooth and Woodgrain</b>					
Actual					
3/4 x 4	ASF03448096PP	ASF03448096PP	—	—	—
1/2 x 4	ASF01248096PP	ASF01248120PP	ASF0128144PP	—	—

	8'	10'	12'	18'	20'
<b>AZEK TO MILL</b>					
Actual					
1 1/4" x 9 1/4" ATM Board Smooth	—	—	—	AT15010216	—
1-1/2" x 3-1/2" ATM Board Smooth	—	—	—	AT20004216	—
1-1/2" x 5-1/2" ATM Board Smooth	—	—	—	AT20006216	—
1-1/2" x 7-1/4" ATM Board Smooth	—	—	—	AT20008216	—
1-1/2" x 9-1/4" ATM Board Smooth	—	—	—	AT20010216	—
1-1/2" x 11-1/4" ATM Board Smooth	—	—	—	AT20012216	—

	8'	10'	12'	18'	20'
<b>AZEK TO MILL (ATM)</b>					
Actual					
1-1/4" x 48" ATM Sheet Smooth	—	AS11448096	—	—	—
1-1/2" x 48" ATM Sheet Smooth	AS11248096	AS11248120	AS11248144	—	AS11248240

		12'	18'	20'
<b>RABBETED TRIM</b>				
Nominal	Actual			
5/4 x 4	1" x 3-1/2" Smooth	—	ATR12504216	—
5/4 x 4	1" x 3-1/2" Woodgrain	—	AFR12504216	—
5/4 x 6	1" x 5-1/2" Smooth	—	ATR12506216	—
5/4 x 6	1" x 5-1/2" Woodgrain	—	AFR12506216	—
5/4 x 8	1" x 7-1/4" Smooth	—	ATR12508216	—
5/4 x 8	1" x 7-1/4" Woodgrain	—	AFR12508216	—

		12'	18'	20'
<b>FLANGE SLOTTED WINDOW TRIM</b>				
Nominal	Actual			
5/4 x 4	Slotted - Smooth	—	ATS12504216	—
5/4 x 4	Slotted - Woodgrain	—	AFS12504216	—
5/4 x 4	Slotted & Rabbeted - Smooth	—	ATSR12504216	—
5/4 x 4	Slotted & Rabbeted - Woodgrain	—	AFSR12504216	—
5/4 x 6	Slotted - Smooth	—	ATS12506216	—
5/4 x 6	Slotted - Woodgrain	—	AFS12506216	—
5/4 x 6	Slotted & Rabbeted - Smooth	—	ATSR12506216	—
5/4 x 6	Slotted & Rabbeted - Woodgrain	—	AFSR12506216	—

		8'	10'	12'	18'	20'
<b>CORNERBOARDS</b>						
Nominal	Actual					
5/4 x 4" x 4"	1" x 3-1/2" Cornerboard Smooth	—	AMT04120C	—	—	AMT04240C
5/4 x 4" x 4"	1" x 3-1/2" Cornerboard Woodgrain	—	AMF04120C	—	—	AMF04240C
5/4 x 6" x 6"	1" x 5-1/2" Cornerboard Smooth	—	AMT06120C	—	—	AMT06240C
5/4 x 6" x 6"	1" x 5-1/2" Cornerboard Woodgrain	—	AMF06120C	—	—	AMF06240C
5/4 x 8" x 8"	1" x 7 1/4" Cornerboard Smooth	—	—	—	—	AMT08240C

		8'	10'	12'	18'	20'
<b>PAINTPRO® CORNERBOARDS</b>						
Nominal	Actual					
5/4 x 4" x 4"	1" x 3-1/2" Cornerboard Smooth	—	—	—	—	AMT04240CPP
5/4 x 4" x 4"	1" x 3-1/2" Cornerboard Woodgrain	—	—	—	—	AMF04240CPP
5/4 x 6" x 6"	1" x 5-1/2" Cornerboard Smooth	—	—	—	—	AMT06240CPP
5/4 x 6" x 6"	1" x 5-1/2" Cornerboard Woodgrain	—	—	—	—	AMF06240CPP

		8'	10'	12'	18'	20'
<b>RABBETED CORNERBOARDS</b>						
Nominal	Actual					
5/4 x 4" x 4"	1" x 3-1/2" Rabbeted - Smooth	—	AMTR04120C	—	—	AMTR04240C
5/4 x 4" x 4"	1" x 3-1/2" Rabbeted - Woodgrain	—	AMFR04120C	—	—	AMFR04240C
5/4 x 6" x 6"	1" x 5-1/2" Rabbeted - Smooth	—	AMTR06120C	—	—	AMTR06240C
5/4 x 6" x 6"	1" x 5-1/2" Rabbeted - Woodgrain	—	AMFR06120C	—	—	AMFR06240C
5/4 x 8" x 8"	1" x 7-1/4" Rabbeted - Smooth	—	—	—	—	AMTR08240C

## AZEK-to-Mill (ATM)

ATM's thick profile makes it an ideal material for fabrication. Its consistent density offers a superior product for milling operations.

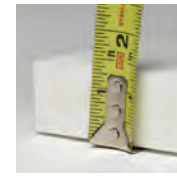

## Rabbeted Trim

With rabbeted edges, this one-piece trimboard is designed to ease siding installation and deliver a crisp facade.

## Flange Slotted Trim

Typical window trims installed over a window nailing fin need to be shimmed or pulled back for the trim to lay flat. Flange Slotted Window Trim does not and is engineered to create consistent long-lasting window surrounds by removing the installation challenges created by windows installed with a nailing fin.

## Cornerboards

With dirt-free seams that will not open, AZEK® Cornerboards offer faster and more aesthetically pleasing installations to complement any home exterior. Available in both classic White and with PaintPro Technology.

## Rabbeted Cornerboards

With rabbeted edges, this one-piece cornerboard is designed to make siding installations a breeze and help deliver a crisp facade with smooth outside edges and dirt-free seams.

## Quick Corner®

The inner and outer quick corners are installed with hidden fasteners, completely eliminating the need for excessive face nailing and touch-up. It is also versatile enough to be used with multiple types of sidings.

## J-Casing

J-Casing offers the most beautiful and seamless transition between your siding and trim. Engineered to reduce labor and save costs by eliminating paint and extra J-channel installs.

## Universal Skirt Board

A two-piece skirt board with a two-sided trimboard (one side in smooth, the other in woodgrain) designed to assist with water management. Routed with a universal siding interface. Installation is quick and easy.

## One-Piece Skirt Board

One-Piece Skirt Board is designed to eliminate purchasing and installing a separate starter strip, skirt board, and flashing while helping drain water away from the main structure. Save time and cost without compromising aesthetics.

## Integrated Drip Edge

Designed to assist with water management efforts around doors and windows. Comes in two pieces with a two-sided trimboard; one side in smooth and the other in woodgrain. Easy to install, the drip edge has an integrated nailing flange to reduce installation time and costs.

		8'	10'	12'	18'	20'
<b>QUICK CORNER® OUTSIDE CORNER</b>						
Nominal	Actual					
5/4 x 4" x 4"	1" x 3-1/2" x 3-1/2" with J-Channel	—	—	—	—	AMT04240JC
5/4 x 6" x 6"	1" x 5-1/2" x 5-1/2" with J-Channel	—	—	—	—	AMT06240JC

		8'	10'	12'	18'	20'
<b>QUICK CORNER® INSIDE CORNER</b>						
Nominal	Actual					
3/8 x 3 x 3	3/8" x 2-1/2" x 2-1/2" with J-Channel	—	—	—	—	AMJCIC03240

		8'	10'	12'	16'	18'	20'
<b>J-CASING</b>							
Nominal	Actual						
1 x 4	1-1/8 x 3-1/2" J-Casing	—	—	—	AMFC04192JCB	AMFC04216JCB	—
1 x 6	1-1/8 x 5-1/2" J-Casing	—	—	AMFC06144JCB	—	—	—
-	1-1/4 x 2" Brick Mould	—	—	—	—	AMBM02216JCB	—

		8'	10'	12'	18'	20'
<b>UNIVERSAL SKIRT BOARD</b>						
Nominal	Actual					
5/4 x 6"	1" x 5-1/2" Universal Skirt Board - Woodgrain	—	—	—	AFUS07216	—
5/4 x 8"	1" x 7-1/4" Universal Skirt Board - Woodgrain	—	—	—	AFUS09216	—
5/4 x 10"	1" x 9-1/4" Universal Skirt Board - Woodgrain	—	—	—	AFUS11216	—
5/4 x 12"	1" x 11 1/4" Universal Skirt Board - Woodgrain	—	—	—	AFUS12216	—

		8'	10'	12'	18'	20'
<b>ONE-PIECE SKIRT BOARD</b>						
Nominal	Actual					
4/4 x 8"	3/4" x 7-1/4" One-Piece Skirt Board - Smooth	—	—	—	ATSB10008216	—
4/4 x 8"	3/4" x 7-1/4" One-Piece Skirt Board - Woodgrain	—	—	—	AFSB10008216	—
4/4 x 10"	3/4" x 9-1/4" One-Piece Skirt Board - Smooth	—	—	—	ATSB10010216	—
4/4 x 10"	3/4" x 9-1/4" One-Piece Skirt Board - Woodgrain	—	—	—	AFSB10010216	—
5/4 x 6"	1" x 5-1/2" One-Piece Skirt Board - Smooth	—	—	—	ATSB12506216	—
5/4 x 6"	1" x 5-1/2" One-Piece Skirt Board - Woodgrain	—	—	—	AFSB12506216	—
5/4 x 8"	1" x 7-1/4" One-Piece Skirt Board - Smooth	—	—	—	ATSB12508216	—
5/4 x 8"	1" x 7-1/4" One-Piece Skirt Board - Woodgrain	—	—	—	AFSB12508216	—
5/4 x 10"	1" x 9-1/4" One-Piece Skirt Board - Smooth	—	—	—	ATSB12510216	—
5/4 x 10"	1" x 9-1/4" One-Piece Skirt Board - Woodgrain	—	—	—	AFSB12510216	—

		8'	10'	12'	16'	18'	20'
<b>ONE-PIECE SKIRT BOARD PAINTPRO</b>							
Nominal	Actual						
5/4 x 10 x 16'	1" x 9 1/4" x 16'	—	—	—	AFSB12510192PP	—	—

		8'	10'	12'	18'	20'
<b>INTEGRATED DRIP EDGE</b>						
Nominal	Actual					
5/4 x 4"	1" x 3-1/2" Integrated Drip Edge	—	—	—	AFWB05216	—
5/4 x 6"	1" x 5-1/2" Integrated Drip Edge	—	—	—	AFWB07216	—
5/4 x 8"	1" x 7-1/4" Integrated Drip Edge	—	—	—	AFWB09216	—

	8'	10'	12'	18'	20'
<b>BEADBOARD, SMOOTH FINISH</b>					
Actual					
3/4" x 5-1/2" Beadboard E & CB	—	—	—	AM1006216ECB	—
1/2" x 3 1/2" Beadboard E & CB	—	—	—	AM01204216ECB	—
3/4" x 3 1/2" Beadboard E & CB	—	—	—	AM1004216ECB	—
5/8" x 3-1/2" Beadboard	—	—	—	AM0620418	—
1/2" x 5-1/2" Beadboard	—	—	—	AM0120618F	—
1/2" x 4' Beadboard Sheet E & CB	AS01248096ECB				

	8'	10'	12'	18'	20'
<b>TONGUE AND GROOVE</b>					
Actual					
3/4" x 5-1/2" WP4/Nickel Gap	—	—	—	AM1006216WPN	—
3/4" x 5-1/2" Tongue & Groove Shiplap	—	—	—	AM10006216TGS	—
3/4" x 7-1/4" Tongue & Groove Shiplap	—	—	—	AM10008216TGS	—

			8'6"	10'
<b>AZEK 3-PLUS-1 COLUMN WRAP</b>				
Nominal	Inside Dimension	Outside Dimension		
4 x 4	3-3/4" x 3-3/4"	4-3/4" x 4-3/4"	ATCW0404096.6	ATCW0404120
6 x 6	5-3/4" x 5-3/4"	6-3/4" x 6-3/4"	ATCW0606096.6	ATCW0606120
8 x 8	7-3/4" x 7-3/4"	8-3/4" x 8-3/4"	ATCW0808096.6	ATCW0808120

	4"	6"
<b>COLUMN KITS AND ACCESSORIES (for 3-Plus-1 Column Wraps only)</b>		
Description		
TRIM KIT - BASE MLDG	ACW4"TRIMKITBASE	ACW6"TRIMKITBASE
TRIM KIT - BED MLDG	ACW4"TRIMKITBED	ACW6"TRIMKITBED
TRIM KIT - BED MLDG XL	ACW4"TRIMKITBEDXL	ACW6"TRIMKITBEDXL
TRIM KIT - CROWN MLDG	ACW4"TRIMKITCROWN	ACW6"TRIMKITCROWN
TRIM KIT - CROWN MLDG XL	ACW4"TRIMKITCROWNXL	ACW6"TRIMKITCROWNXL
ACCENT WRAP 10"	ACWAW040410	ACWAW060610 <small>* for use with Accent Wraps.</small>

	5'	6'
<b>TAPERED COLUMN WRAP</b>		
Actual		
12" base / 8" cap x 5' Tapered Column Wrap	ATCWT1208060	ATCWT1208072
16" base / 12" cap x 6' Tapered Column Wrap	ATCWT1612060	ATCWT1612072

		12'	18'	20'
<b>SOFFIT SYSTEM</b>				
Nominal	Actual			
1/2 x 12	1/2" x 12" Vented Soffit	—	ATVS01212216	—
1/2 x 16	1/2" x 16" Vented Soffit	—	ATVS01216216	—
1/2 x 12	1/2" x 12" Solid Soffit	—	ATSS01212216	—
1/2 x 16	1/2" x 16" Solid Soffit	—	ATSS01212216	—
1 x 8	3/4" x 7-1/4" Notched Fascia	—	AT10008216NF	—
5/4 x 6	5/4 x 6 Frieze Board	—	AT12508216FB	—

## Beadboard

AZEK® Beadboard is reversible with an edge and center bead on one side and a v-groove on the other. AZEK Beadboard (E & CB) is certified UL580 class 90 wind gust uplift-resistant, making it ideal for use in coastal areas.

## Nickel Gap and Shiplap

AZEK Tongue-and Groove profiles, available in shiplap and reversible WP4/nickel gap form factors, offer enhanced design and installation flexibility.

## Column Wrap

AZEK Column Wrap profile allows for easy one-person installation, saving time and costs. Three connected panels and a fourth "locking" panel fit easily around a structural support with press fit seams and smooth, finished corners. AZEK Column Wrap is available in semi-Matte White smooth finish.

## Soffit System

Available in two profiles, solid and vented. Both provide climate-resistant material for smooth, beautiful finishing to match any home exterior. Add the notched fascia and frieze board and you have an efficient, easy-to-install system.



# AZEK MOULDING

STUNNING DETAILS THAT LAST.

Backed by AZEK's promise of high-quality and lasting performance, AZEK® Moulding will retain a like-new appearance despite the tests of time and weather. With over 30 different profiles to mix and match, you can customize any build with a distinctive look.



## Detail and Sill/Drip Profiles

The AZEK Drip Cap can be used as a water table or brick ledge for separation and watershed against two different materials. AZEK's Sill profiles shed water and offer architectural detail.

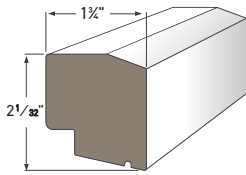

**HISTORIC SILL**  
AZM-6930  
Length: 16'

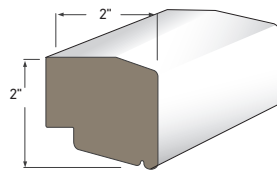

**LARGE SILL NOSE**  
AZM-7979  
Length: 16'

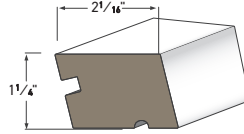

**WINDOW SILL NOSE**  
AZM-7974  
Length: 12'

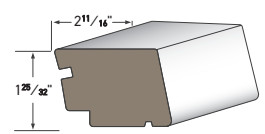

**LARGE HISTORIC SILL**  
AZM-7958  
Length: 16'

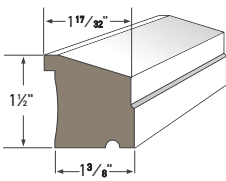

**SUB SILL NOSE**  
AZM-6933  
Length: 16'

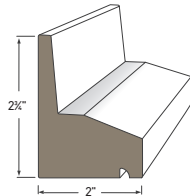

**WATER TABLE**  
AZM-6935  
Length: 18'

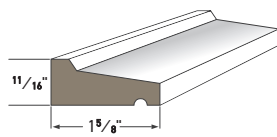

**DRIP CAP**  
AZM-197  
Length: 16'

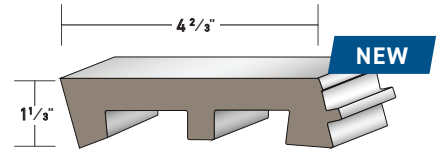

**PCB SILL**  
AZM-948  
Length: 16'

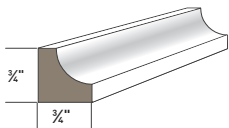

**SCOTIA**  
AZM-93  
Length: 16'

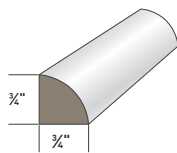

**QUARTER ROUND**  
AZM-105  
Length: 16'

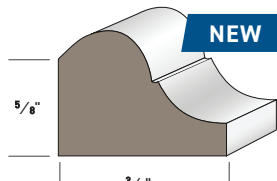

**NOSE COVE**  
AZM-7480  
Length: 16'

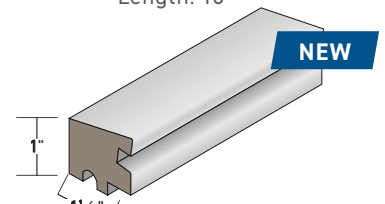

**SILL NOSE**  
AZM-937  
Length: 16'



# Crown Profiles

Use AZEK® Crown Moulding as decorative accents along the intersection of a wall and ceiling or choose a combination of profiles to create an elegantly custom look.

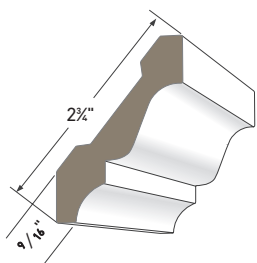

**3" CROWN**  
AZM-52  
Length: 16'

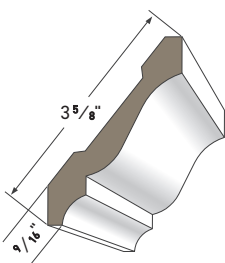

**4" CROWN**  
AZM-49  
Length: 16'

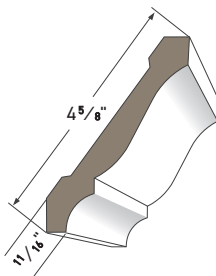

**5" CROWN**  
AZM-47  
Length: 16'

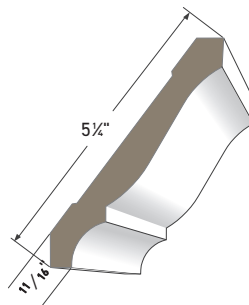

**6" CROWN**  
AZM-45  
Length: 16'

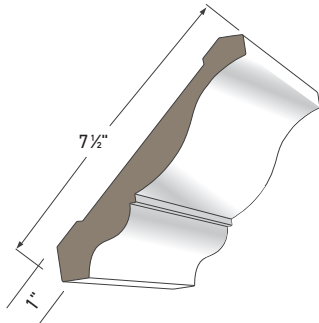

**8" CROWN**  
AZM-43  
Length: 16'

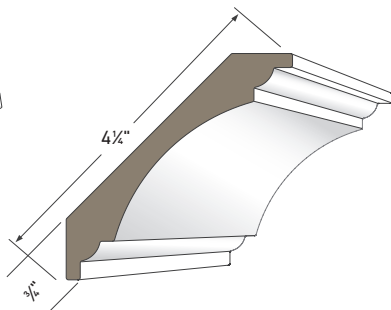

**COVE MOULDING**  
AZM-80  
Length: 16'

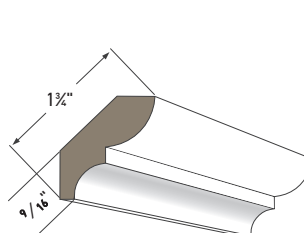

**BED MOULDING**  
AZM-75  
Length: 16'

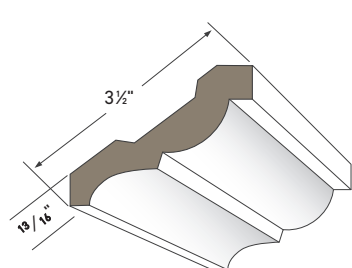

**3 1/2" BED MOULDING**  
AZM-28  
Length: 16'

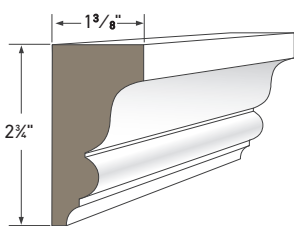

**IMPERIAL RAKE CROWN**  
AZM-6937  
Length: 16'

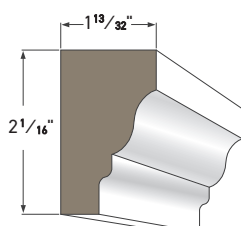

**RAMS CROWN**  
AZM-6934  
Length: 16'

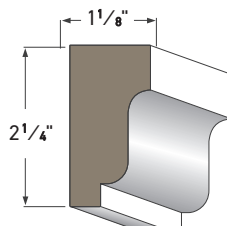

**SOLID CROWN**  
AZM-7954  
Length: 16'

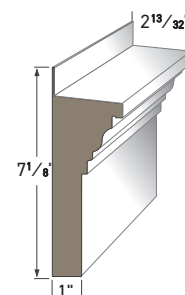

**CROSSHEAD PEDIMENT**  
AZM-6216  
Length: 18'

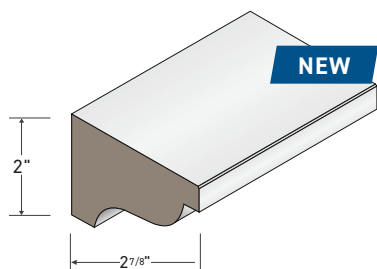

**PEDIMENT CROWN MOULDING**  
AZM-1882  
Length: 12'

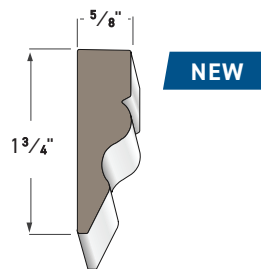

**PANEL MOULD**  
AZM-165  
Length: 16'

# Casing Profiles

Use AZEK® Casing profiles as decorative mouldings against a wall, door, or window to create surrounds. Complement windows and doors with a single profile or combine multiple profiles for a personalized exterior transformation.

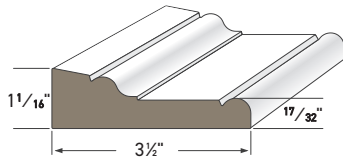

**ADAMS CASING AZM-97**  
Length: 16'

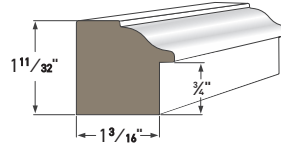

**BACK BAND AZM-6931**  
Length: 16'

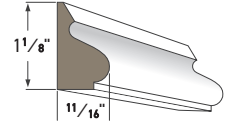

**BASE CAP AZM-164**  
Length: 16'

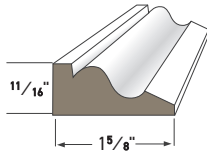

**BAND AZM-217**  
Length: 16'

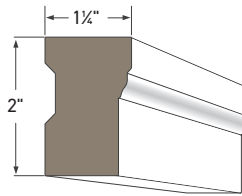

**BRICK MOULD AZM-180**  
Lengths: 16, 17' and 18'

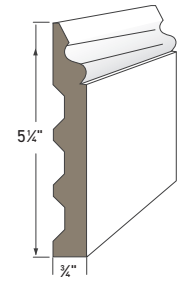

**COLONIAL BASE CAP AZM-163**  
Length: 16'

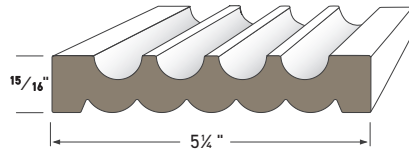

**FLUTED/REEDED AZM-606**  
Length: 16'

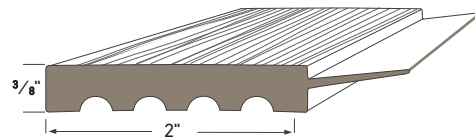

**GARAGE DOOR THERMOSTOP AZM-6936**  
Lengths: 7', 9', and 16'

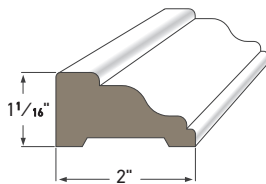

**RAKE MOULDING AZM-287**  
Length: 16'

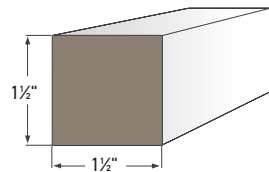

**SQUARE PROFILE AZM-236**  
Length: 12'

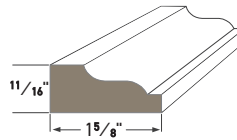

**SHINGLE MOULD AZM-210**  
Length: 16'

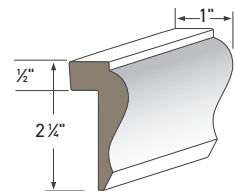

**WAINSCOT CAP AZM-284**  
Length: 16'

	AZEK Item Number			
	12'	16'	17'	18'
<b>MOULDING</b>				
Actual				
9/16" x 2-3/4" 3" Crown AZM-52	—	AMCM03192	—	—
9/16" x 3-5/8" 4" Crown AZM-49	—	AMCM04192	—	—
11/16" x 4-5/8" 5" Crown AZM-47	—	AMCM05192	—	—
11/16" x 5-1/4" 6" Crown AZM-45	—	AMCM06192	—	—
1" x 7-1/2" 8" Crown AZM-43	—	AMCM08192	—	—
3/4" x 4-1/4" Cove Moulding AZM-80	—	AMCC05192	—	—
1-13/32" x 2-1/16" Rams Crown AZM-6934	—	AMRC02192	—	—
1-3/8" x 2-3/4" Imperial/Rake Crown AZM-6937	—	AMIR03192	—	—
9/16" x 1-3/4" Bed Moulding AZM-75	—	AMBD02192	—	—
13/16" x 3-1/2" Bed Moulding AZM-28	—	AMBD04192	—	—
3/4" x 3/4" Scotia AZM-93	—	AMSC01192	—	—
3/4" x 3/4" Quarter Round AZM-105	—	AMQR01192	—	—
11/16" x 1-5/8" Shingle Mould AZM-210	—	AMSM02192	—	—
11/16" x 1-5/8" Band Moulding AZM-217	—	AMBN02192	—	—
1" x 2-1/4" Wainscot Cap AZM-284	—	AMWC03192	—	—
11/16" x 1-1/8" Base Cap AZM-164	—	AMBC02192	—	—
1-1/4" x 2" Brick Mould AZM-180	—	AMBM02192	AMBM02204	AMBM02216
1-11/32" x 1-3/16" Back Band AZM-6931	—	AMBB02192	—	—
1-1/16" x 2" Rake Moulding AZM-287	—	AMRM02192	—	—
1-1/16" x 3-1/2" Adams Casing AZM-97	—	AMAC04192	—	—
3/4" x 5-1/4" Colonial Base Cap AZM-163	—	AMCB06192	—	—
15/16" x 5-1/4" Fluted/Reeded Casing AZM-606	—	AMFR06192	—	—
Crosshead Pediment AZM-6216	—	—	—	AMCP04216
1-1/2" x 1-1/2" Square AZM-236	AMIC02144	—	—	—
11/16" x 1-5/8" Drip Cap AZM-197	—	AMDC02192	—	—
2-3/4" x 2" Water Table AZM-6935	—	—	—	AMWT03216
1-3/4" x 2-1/32" Historic Sill AZM-6930	—	AMHS02192	—	—
1-17/32" x 1-1/2" x 1-3/8" Sub Sill Nose AZM-6933	—	AMSS02192	—	—
1-1/8" x 2-1/4" Solid Crown AZM-7954	—	AMCM02192CB	—	—
1-25/32" x 2-11/16" Large Historic Sill AZM-7958	—	AMHS03192CB	—	—
2"x 2" Large Sill Nose AZM-7979	—	AMLSN02192CB	—	—
1-1/4" x 2-1/16" Window Sill Nose AZM-7974	AMWSN02144CB	—	—	—
1 3/8" x 1 1/4" Sill Nose AZM-937	—	AMSN01192	—	—
2 7/8" x 2" Pediment Crown Moulding AZM-1882	AMPC02144	—	—	—
4 11/16" x 1 1/4" PCB Sill AZM-948	—	AMS05192	—	—
1 3/4" x 5/8" Panel Mould AZM-165	—	AMPM02192	—	—
3/4" x 5/8" Nose Cove AZM-7480	—	AMNC01192	—	—

	AZEK Item Number				
	7'	9'	12'	16'	18'
<b>GARAGE DOOR THERMOSTOP AZM-6936</b>					
Actual					
3/8" x 2" Garage Door Thermostop AZM-6936	AMGT03084	AMGT03108	—	AMGT03192	—

**Industry-Leading Warranties**

With decades in the business partnered with dedicated investments to research and development, AZEK provides the best materials on the market. We guarantee the integrity of our siding, cladding, trim and moulding with a Lifetime Limited Warranty that covers rotting, splintering, peeling, and warping. It is also easy to maintain and resistant to mold, mildew, and moisture damage. For more information, visit [AZEKexteriors.com/warranty](http://AZEKexteriors.com/warranty).

**Contractor and Builder Information**

AZEK® Siding, Cladding, Trim & Moulding should be installed using the same good building principles used to install wood trim and mouldings and in accordance with the local building codes and established installation guidelines. AZEK accepts no liability or responsibility for the improper installation of this product.

AZEK® Siding, Cladding, Trim & Moulding may not be suitable for every application and it is the sole responsibility of the installer to be sure that AZEK Siding, Cladding, Trim and Moulding, are fit for the intended use. Since all installations are unique, it is also the installer's responsibility to determine specific requirements in regard to each application. AZEK recommends that all applications be reviewed by a licensed architect, engineer, or local building official before installation.



# AZEK PREMIUM SIDING

THREE DISTINCTIVE LOOKS, ONE SUPERIOR MATERIAL

AZEK Siding® choices offer style, durability, and low maintenance. The familiar looks of traditional wood exteriors meet the advanced engineering of ready-for-paint AZEK PVC. Water and moisture, wood's worst enemy, is no match for AZEK. Contemporary to farmhouse, colonial to coastal, AZEK siding is the best choice for both new construction and R&R.



## AZEK Shingle Siding with PaintPro® Technology

The sought-after texture and random appearance of traditional cedar shingles is recreated in AZEK's panelized, easy-to-install shingle siding system. PaintPro Technology means paint goes on smoother, adheres stronger, and lasts longer than any other PVC or other competitive product. Three reveals, straight and staggered, offer choices to complement any design.

SHINGLE SIDING		
5" Reveal Straight Edge Shingle Panel	48" x 12" x 1/4"	ASSTRE02512048
7" Reveal Straight Edge Shingle Panel	48" x 16" x 1/4"	ASSTRE02516048
6" Reveal Staggered Edge Shingle Panel	48" x 15" x 1/4"	ASSTGE02515048

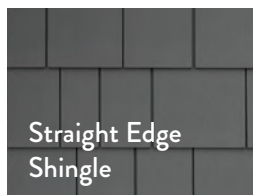



## Premium AZEK Bevel Siding

AZEK® Bevel looks so much like real cedar siding, it can repair and replace rotted cedar boards seamlessly. When it wraps an entire house, rot is a thing of the past. Installs with face nailing and without knots or finger-joints. Ready to paint without priming, AZEK Bevel creates a traditional look with the freedom of low, low maintenance.

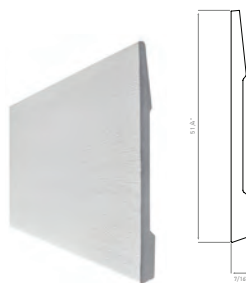

Bevel Siding		
Dimensions	Reveal	Length
5.25" x 7/16"	4"	12'



## AZEK Board and Batten

AZEK Sheet is the “board” and AZEK Trim boards are the “batten” components of this exterior system. Multiple widths of the battens are available, and spacing on the sheet board is almost limitless. Available ready-to-paint, enhanced with PaintPro Technology or in classic, semi-Matte White. See available Sheet and Trim sizes on page 6.

AZEK Item Number			
		12'	16'
Batten Strips with PaintPro® Technology			
Nominal	Actual		
4/4 x 2	3/4" x 1-1/2"	—	AF10002192PP
4/4 x 3	3/4" x 2-1/2"	—	AF10003192PP

AZEK Item Number				
		8'	10'	12'
Boards (PVC Sheet) s with PaintPro® Technology				
Actual				
3/4 x 4	ASF03448096PP	ASF03448096PP	—	
1/2 x 4	ASF01248096PP	ASF01248120PP	ASF0128144PP	



## TimberTech® Cladding by AZEK

The incredible realism of TimberTech Cladding comes from science and art. Proprietary color blending and texturing processes capture the look of exotic hardwoods, while the advanced PVC construction ensures decades of low-maintenance, enduring good looks. Color, board width, and open- and closed-joint profile options create unlimited design possibilities for both residential and commercial applications. Find details on the Vintage Collection® and Landmark Collection® on pages 7 and 8.

## Class A Flame Spread Index

TimberTech Cladding in the Vintage and Landmark Collections carry a Class A (the highest ranking Flame Spread Index), meaning it is most likely to minimize the spread of an active flame. The Vintage Collection is also WUI-compliant. This can be especially important in multi-family construction or for building in fire-prone areas.



DECKING COLOR	3" WIDE TONGUE-AND-GROOVE	5½" WIDE TONGUE-AND-GROOVE	3¼" NARROW Square-Shouldered	5½" STANDARD Square-Shouldered	7½" WIDE Square-Shouldered
COASTLINE®	12' or 16'	12' or 16'	16'	16'	16'
DARK HICKORY	12' or 16'	12' or 16'	16'	16'	16'
MAHOGANY	12' or 16'	12' or 16'	16'	16'	16'
WEATHERED TEAK®	12' or 16'	12' or 16'	16'	16'	16'
CYPRESS®	12' or 16'	12' or 16'	16'	16'	16'
ENGLISH WALNUT®	12' or 16'	12' or 16'	16'	16'	16'
FRENCH White OAK®	—	—	—	16'	—
CASTLE GATE™	—	—	—	16'	—
AMERICAN WALNUT®	—	—	—	16'	—
BOARDWALK	—	—	—	16'	—

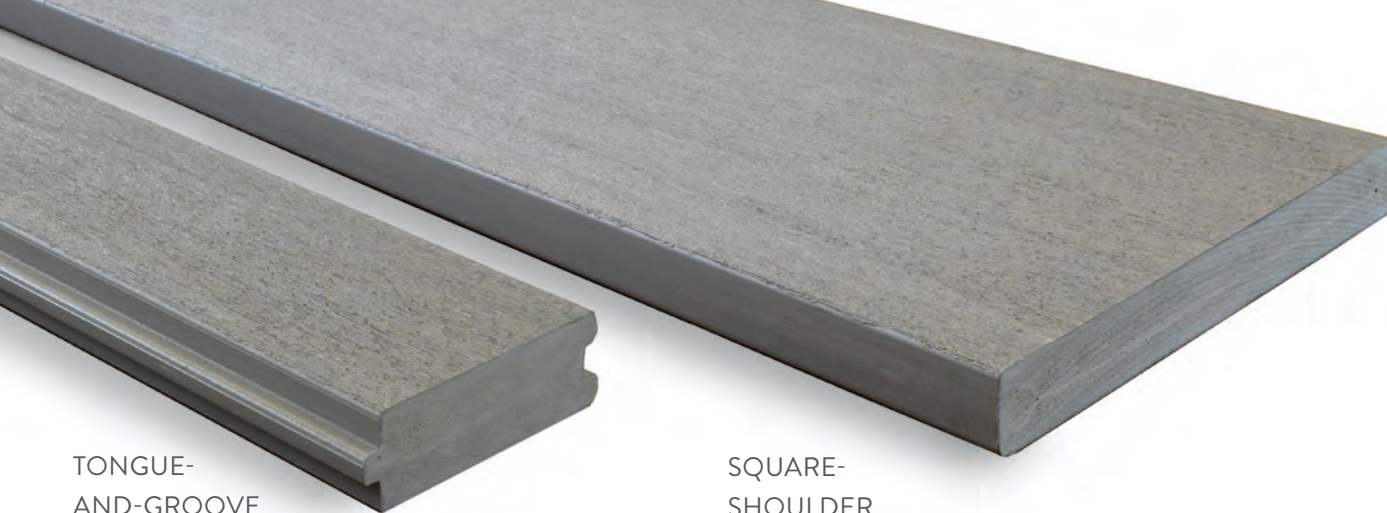

TONGUE-AND-GROOVE

SQUARE-SHOULDER

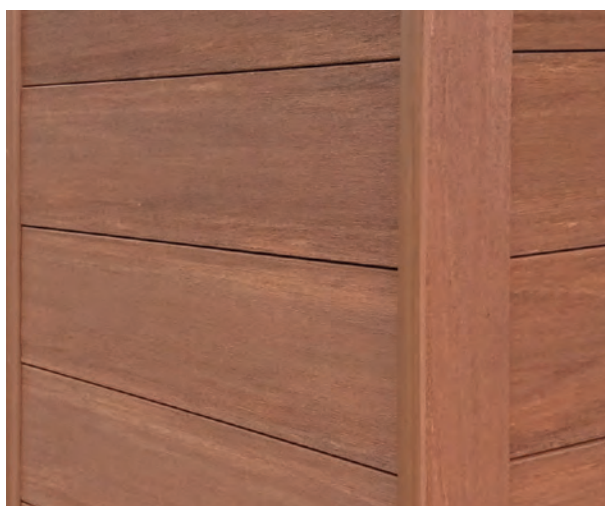

### Closed-Joint Cladding

Sometimes referred to as “closed-joint,” tongue-and-groove boards interlock together with ease, creating a solid barrier with a neat, smoothly finished look without gaps.

TONGUE-AND-GROOVE BOARD SIZES:



### Open-Joint Cladding

The open joints between the cladding elements create a strong, linear design pattern while also functionally providing ventilation for proper air circulation.

SQUARE-SHOULDERED BOARD SIZES:



MADE IN THE USA

# Adhesive and Tools

Quickly, easily, and securely bond AZEK trim to multiple surfaces with AZEK® adhesives engineered specifically to bond with PVC products. Get a permanent solution for core-to-core bonding, surface bonding, sealing, and filling PVC trim and moulding for an attractive finish.



	AZEK Item Number					
	4 OZ	8 OZ	16 OZ	32 OZ	128 OZ	640 OZ
<b>PVC CEMENT</b>						
Cellular PVC Cement	AAD004OZ	AAD008OZ	AAD016OZ	AAD032OZ	AAD128OZ	AAD640OZ

	AZEK Item Number					
	4 OZ	8 OZ	16 OZ	32 OZ	128 OZ	640 OZ
<b>PVC CEMENT SQUEEZE BOTTLE</b>						
Cellular PVC Cement	AADB004OZ	AADB008OZ				

	AZEK Item Number	
	50 ML	220 ML
<b>FAST CURE/SLOW CURE ADHESIVES &amp; TOOLS</b>		
Fast Cure Structural Adhesive	AAD50MLFCS	AAD220MLMLFCS
Slow Cure Structural Adhesive	AAD50MLSCS	AAD220MLSCS
Qwik-Mixers	AAD50MLSQM	AAD220MLQM
Manual Dispense Gun	AAD50MLMG	AAD220MLHF

	AZEK Item Number
<b>ADHESIVE &amp; TOOLS</b>	
Fill & Flex, 300 ml	AAD300MLFF
Nail Eraser, 0.5 oz	AADNEBLIS
Plastic Joining Biscuits	AADPJB
AZEK Adhesive Opening Order SKU	AAD14POOS





## Fast Cure Adhesive

White, two-part, acrylic-based adhesive ideal for bonding AZEK to AZEK products. Also bonds PVC to wood, metal, brick, vinyl, glass, and other PVC. Work time 4-7 minutes at 70°F. Fully cures in 24 hours. Fills nail holes and gaps up to 1/8". Requires Qwik-Mixer for easy mixing and dispensing.



## Slow Cure Adhesive

White, two-part, acrylic-based adhesive ideal for bonding AZEK to AZEK products. Also bonds PVC to wood, metal, brick, vinyl, glass and other PVC. Work time 15-25 minutes at 70°F. Fully cures in 24 hours. Fills nail holes and gaps up to 1/2". Requires Qwik-Mixer for easy mixing and dispensing.



## Cellular PVC Cement

Clear, contact-style adhesive bonds with PVC in a fast working time. Ideal for securing joints. Creates a powerful and reliable material bond with no sanding or scraping required. Use AZEK Cellular PVC Cement to connect trim when a tight compression is required, such as connecting trim end-to-end (scarf joints) and at corners (miter joints).



## Fill & Flex

Use for expansion and contraction joints on PVC trim boards. Seals gaps around windows and doors. Slow curing, one-part, urethane-based sealant with high level of flexibility and elongation to absorb expansion and contraction from heat or cold.

## Adhesive Accessories



**QWIK-MIXERS**  
50 ml: AAD50MLSQM,  
220 ml: AAD220MLQM

Required dispenser for Fast Cure and Slow Cure AZEK Adhesive products. The resin and catalyst blend together as they travel down the tube to the applicator tip. Ensures 1:1 ratio mix and provides easy adhesive application. 24 per pack.



**NAIL ERASER**  
Fills finish nail and brad holes in PVC trim board. Resists yellowing. .5oz



**MANUAL 220 ML DISPENSING GUN**  
Its 26:1 mechanical advantage dispenses high and low viscosity adhesives with less user fatigue. Designed to maximize durability.



**MANUAL 50 ML DISPENSING GUN**  
Made of highly engineered plastic to be lightweight and powerful. Easy loading breech provides secure cartridge fit.



**PLASTIC JOINING BISCUITS**  
Easy way to join, seal and finish PVC trim. 50 per pack.



# CORTEX®

Save time, money, and labor costs with Cortex for AZEK® Trim. The only concealed fastening system that quickly and easily fastens AZEK Trim to your building project comes with collated strips of matching AZEK plugs to make fastening up to 50% faster. The felt tip on the unique bit prevents surface marring while driving fasteners securely below the trim surface. Plugs made of AZEK Trim tap in for a clean, flush finish. No mess or fading over the life of the project. Plus, Cortex fasteners offer a stronger connection than nails.

## Cortex Benefits

- Fast and easy; eliminates the need to caulk, sand and paint each nail hole
- Plugs made out of same AZEK material as trim; eliminates fading or streaking
- Can be painted
- Guaranteed corrosion resistance for life of the project; ACQ approved



AZEK Item Number	
<b>CORTEX® PLUGS, NO SCREWS</b>	
Smooth Collated Cortex - 40 Plugs (no screws)	ATCTC40PC
Woodgrain Collated Cortex - 40 Plugs (no screws)	AFCTC40PC

	AZEK Item Number		
	50 LN FT	250 LN FT	750 LN FT
<b>SCREW, PLUG AND BIT KITS</b>			
Smooth Cortex 2" Screws	ATCTL50LF200	ATCTL250LF200	ATCTL750LF200
Smooth Collated Cortex 2" Screws	—	ATCTC250LF200	ATCTC750LF200
Smooth Cortex 2-3/4" Screws	ATCTL50LF275	ATCTL250LF275	ATCTL750LF275
Smooth Collated Cortex 2-3/4" Screws	—	ATCTC250LF275	ATCTC750LF275
Woodgrain Cortex 2" Screws	AFCTL50LF200	AFCTL250LF200	AFCTL750LF200
Woodgrain Collated Cortex 2" Screws	—	AFCTC250LF200	AFCTC750LF200
Woodgrain Cortex 2-3/4" Screws	AFCTL50LF275	AFCTL250LF275	AFCTL750LF275
Woodgrain Collated Cortex 2-3/4" Screws	—	AFCTC250LF275	AFCTC750LF275

	AZEK Item Number		
	50 LN FT	250 LN FT	750 LN FT
<b>PAINTPRO® SCREW, PLUG AND BIT KITS</b>			
Smooth Collated Cortex 2" Screws	—	ATCTC250LF200PP	ATCTC750LF200PP
Smooth Collated Cortex 2-3/4" Screws	—	ATCTC250LF275PP	ATCTC750LF275PP
Woodgrain Collated Cortex 2" Screws	—	AFCTC250LF200PP	AFCTC750LF200PP
Woodgrain Collated Cortex 2-3/4" Screws	—	AFCTC250LF275PP	AFCTC750LF275PP



Paintable Cortex  
for PaintPro Trim



TIMBERTECH.COM  
877-275-2935  
AZEKEXTERIORS.COM  
1-800-910-3545

**TimberTech**  
BY AZEK

**AZEK**  
EXTERIORS

LIT-PRODUCTGUIDE  
REV 12/23